



# *Les essentiels Sanitaire*



TARIF PUBLIC INDICATIF HT  
AU 1ER JANVIER 2013

<b>RECEVEURS</b>		<b>6</b>
	ALLIA	BASTIA 6
		PRIMA 6-7
	VILLEROY & BOCH	O'NOVO 7-8
		LIFETIME 8
		SUBWAY 9-10
		FUTURION 10
	IDEAL STANDARD	ULYSSE 10
		CONNECT 11
		FLAT 11
<b>BAIGNOIRES</b>		<b>12</b>
	ALLIA	BASTIA 12
		PRIMA STYLE 12
	VILLEROY & BOCH	VOLTA 12
		TARGA 13
	IDEAL STANDARD	ULYSSE 13
		CONNECT 13
<b>VASQUES</b>		
<b>LAVABOS COLONNE</b>		
<b>BIDETS</b>		
<b>RÉSERVOIRS EQUIPES</b>		
<b>WC A POSER</b>		
<b>WC SUSPENDU</b>		<b>20</b>
	ALLIA	20
	VILLEROY & BOCH	21
	IDEAL STANDARD	22
<b>PACK WC</b>		<b>23</b>
	ALLIA	23-24
	VILLEROY & BOCH	24-25
	IDEAL STANDARD	26
<b>BATI SUPPORT</b>		<b>27</b>
	GROHE	27
	SIAMP	27-28
<b>LAVE-MAINS</b>		
	ALLIA	28-29
	VILLEROY & BOCH	29-30
	IDEAL STANDARD	30
<b>EVIERS</b>		<b>31</b>
<b>EVIERS GRES</b>		
	ALLIA	31-32
	VILLEROY & BOCH	32-33
<b>EVIERS RESINE</b>		
	AQUATOP	33
<b>EVIERS INOX</b>		
	MODERNA	34
<b>BACS A LAVER</b>		
	ROMAY	37
<b>COLLECTIVITES</b>		
	ALLIA	35-36
	IDEAL STANDARD	37

<b>MELANGEURS</b>			<b>38</b>
	IDEAL STANDARD	ULYSSE	38
<b>MITIGEURS</b>			<b>39</b>
	GROHE	EUROECO	39
		EUROSMART	40
		EUROSMART COSMOPOLITAN	41
		EUROSTYLE	42
		EUROSTYLE COSMOPOLITAN	43
		CONCETTO	44-45
		ESSENCE	45-46
		BAUEDGE 	47
		EURODISC	47
	HANSA	POLO	49
		PINTO	50
		PRADO	51
		VANTIS	52
	IDEAL STANDARD	OLYOS	52-53
		CONNECT	53-54
	ONDYNA	NEW WAY	56
<b>ROBINETTERIE TEMPORISEE</b>			<b>59</b>
	PRESTO		59-61
	DELABIE		62-64
<b>MITIGEURS THERMOSTATIQUES</b>			<b>65</b>
	GROHE		65-66
	HANSA		66-67
	IDEAL STANDARD		67
<b>ENSEMBLES THERMOSTATIQUES</b>			<b>68</b>
	HANSA		68
	ONDYNA		68
	GROHE		69
	HANSGROHE		69
<b>ENSEMBLES DE DOUCHE</b>			<b>70</b>
	GROHE		70-71
	HANSGROHE		71-73
	VALENTIN		75-77
<b>PAROIS DE DOUCHE</b>			<b>78</b>
	NOVELLINI		78
	SANSWISS 		78-80
<b>CABINE DE DOUCHE</b>			<b>81</b>
	LEDA		81

Le présent catalogue est édité pour les années 2013 et 2014. les prix y figurant correspondent aux prix publics conseillés HT sont fournis à titre indicatif et sont susceptibles de varier en fonction des hausses tarifaires pratiquées par nos fournisseurs. Veuillez contacter nos agences ou vous connecter à e.BAT pour connaître le tarif en vigueur.

<b>MEUBLES DE SALLE DE BAINS</b>		<b>82</b>
AQUARINE	PREFIXE	82-83
DELPHA	FEDO	83
	PROMOULE	83-84
	PROCERAM DECO	84
	D-MOTION 	85-87
<b>MEUBLES SOUS EVIER</b>		<b>88</b>
AQUARINE	LIBERTY	88
<b>CUISINETTES</b>		<b>88</b>
MODERNA		88
<b>MEUBLES LAVE-MAINS</b>		<b>88</b>
SANIJURA	POP	88
<b>ACCESSOIRES</b>		<b>90</b>
RÉSERVOIRS WC		90
MÉCANISMES WC	SIAMP	90-91
ABATTANTS WC	SIAMP	92
BROYEURS WC	WATERMATIC	93
	SFA	93
VIDADES	VALENTIN	94
BONDES	VALENTIN	95-96
SIPHONS	VALENTIN	97
ACCESSOIRES DE TOILETTES	PELLET	98-101
	INDA	102-103
MIROIRS DE TOILETTES	CEDAM	103



## RECONNAÎTRE LES LOGOS



Produits exclusifs Espace Aubade



Le meilleur rapport qualité/prix Espace Aubade



Retrouvez votre catalogue en ligne sur  
[www.espace-aubade.fr](http://www.espace-aubade.fr)  
Rubrique **PRO**  
ou demandez vos codes d'accès à votre représentant



### CONSULTEZ :

- Vos devis
- Vos commandes
- Le stock disponible
- Le tarif public et vos conditions d'achat

### COMMANDEZ :

- Basculez vos devis en commande
- Demandez la livraison de vos produits en 48 heures



NOUVEAU

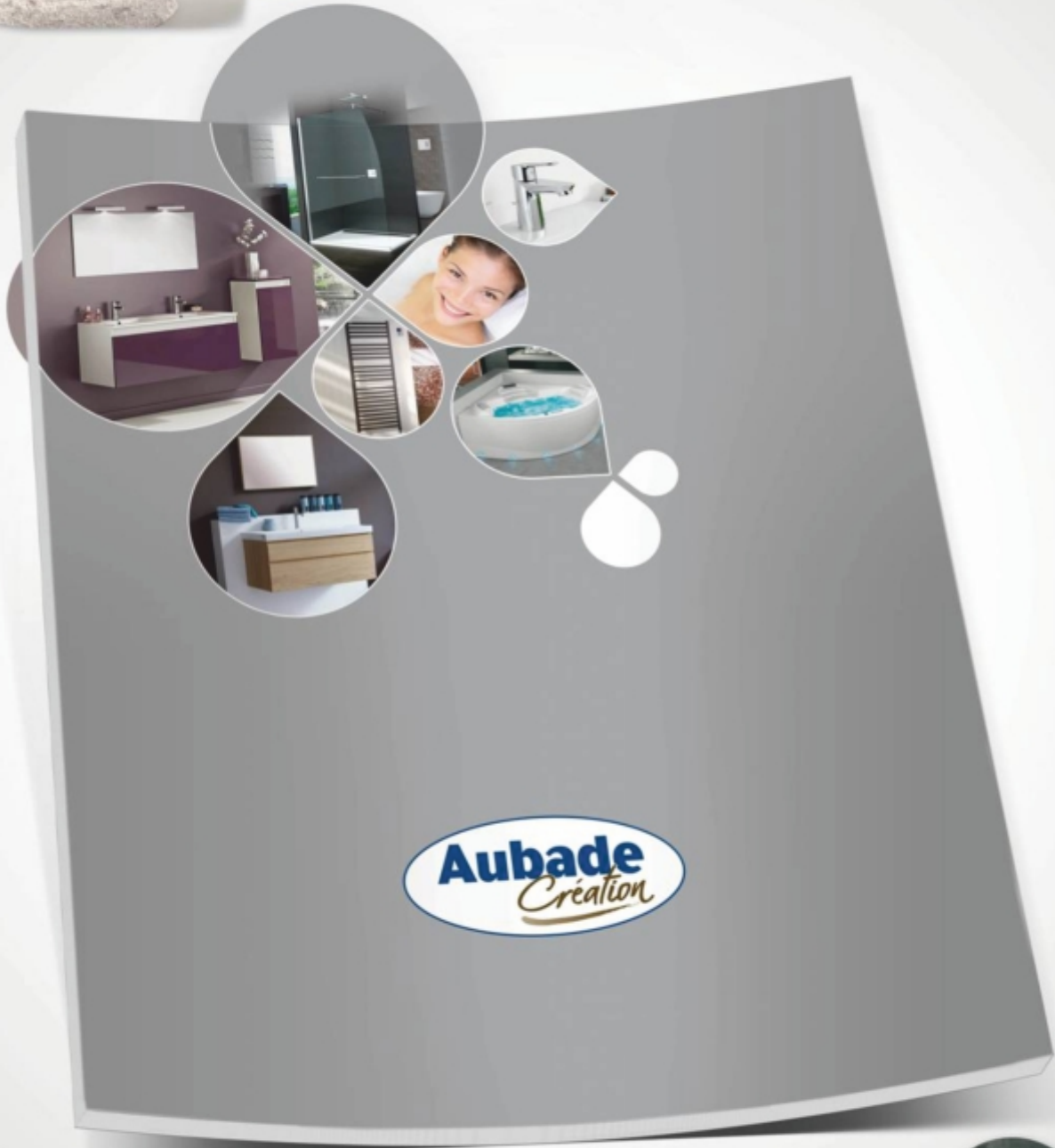

COLLECTION EXCLUSIVE  
2013



→ RECEVEURS BASTIA



BASTIA - RECEVEUR A ENCASTRER BLANC						
Référence	Code	Taille/Format	A	B	C	Prix public HT
00714100000	C23276	80 x 80	800	800	700	110,71€
00736100000	C25334	90 x 90	900	900	790	188,92€

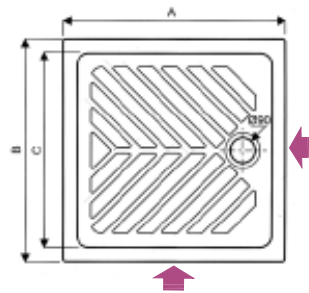

BASTIA - RECEVEUR A POSER BLANC						
Référence	Code	Taille/Format	A	B	C	Prix public HT
00725100000	C22994	70 x 70	700	700	610	97,00€
00728100000	C23293	80 x 80	800	800	700	110,71€
00726100000	C65012	90 x 90	900	900	800	188,92€

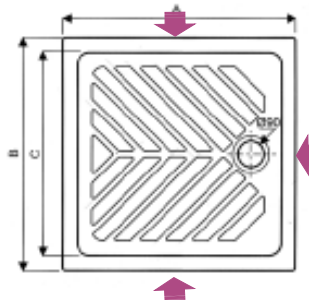

BASTIA - RECEVEUR 1/4 ROND BLANC						
Référence	Code	Taille/Format	A	B	C	Prix public HT
00705100000	C71386	90 x 90	900		900	380,00€

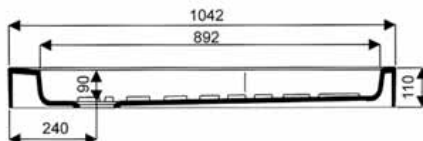
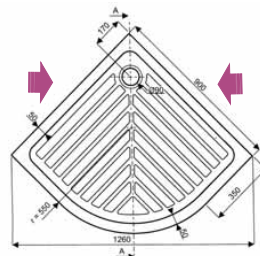

→ RECEVEURS PRIMA



PRIMA - RECEVEUR A ENCASTRER EXTRA PLAT BLANC						
Référence	Code	Taille/Format	A	B	C	Prix public HT
00731200000	C23027	80 x 80	800	800	700	193,00€
00734300000	C23286	90 x 90	900	900	800	259,00€
00731200000AG2*	C2328V	80 x 80	800	800	700	221,00€
00734300000AG2*	C13068	90 x 90	900	900	800	233,28€

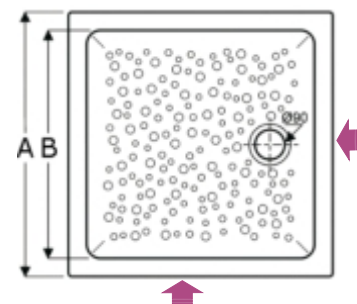

\* Revêtement Antigliss

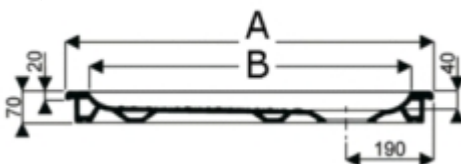

PRIMA - RECEVEUR A ENCASTRER EXTRA PLAT BLANC						
Référence	Code	Taille/Format	A	B	C	Prix public HT
00736200000	C7186C	100 x 80	1000	800	900	305,00€
00737200000	C7186E	120 x 80	1200	800	1100	344,00€

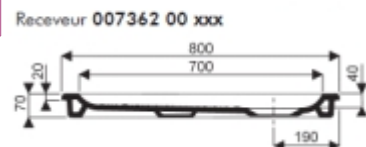
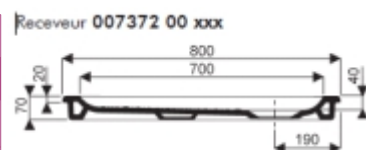

→ Face non émaillée

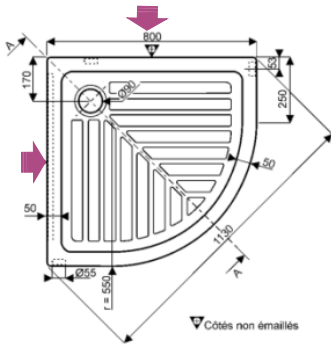

PRIMA - RECEVEUR 1/4 ROND SURÉLEVÉ BLANC			
Référence	Code	Taille/Format	Prix public HT
00708100000	C23266	80 x 80	386,00€

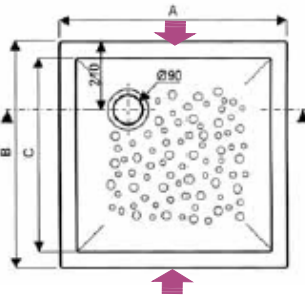
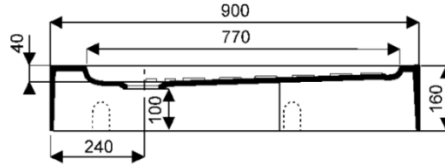

PRIMA - RECEVEUR A POSER EXTRA PLAT BLANC						
Référence	Code	Taille/Format	A	B	C	Prix public HT
00721200000	C23028	80 x 80	800	800	700	193,00€
00723200000	C71868	90 x 90	900	900	800	259,00€
00721200000AG1*	C2329A	80 x 80	800	800	700	171,40€
00723200000AG1*	C7186T	90 x 90	900	900	800	233,28€



\* Revêtement Antigliss

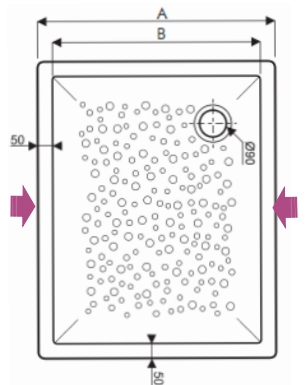

PRIMA - RECEVEUR A POSER EXTRA PLAT BLANC							
Référence	Code	Taille/Format	A	B	C	D	Prix public HT
00725200000	C7186B	90 x 70	900	700	800	600	260,00€
00728200000	C7186D	100 x 80	1000	800	900	700	305,00€
00729200000	C7186F	120 x 80	1200	800	1100	700	344,00€
00728200000AG1*	C7186N	100 x 80	1000	800	900	700	351,00€
00729200000AG1*	C7186P	120 x 80	1200	800	1100	700	397,00€

\* Revêtement Antigliss

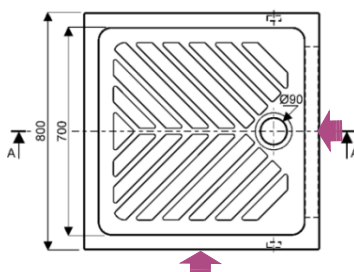
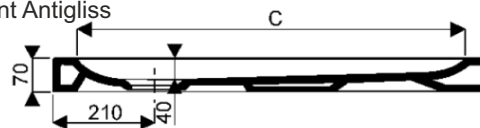

PRIMA - RECEVEUR SURÉLEVÉ BLANC						
Référence	Code	Taille/Format	A	B	C	Prix public HT
007161000000	C23282	80 x 80	800	800	700	238,00€

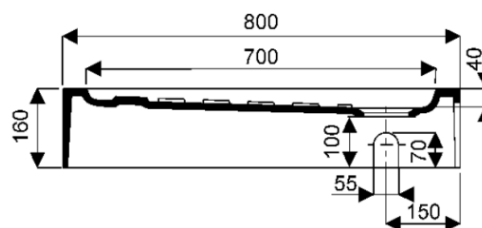



O'NOVO - RECEVEUR A ENCASTRER BLANC							
Référence	Code	Taille/Format	A	B	C	D	Prix public HT
6027A701	CA016T	70 x 70/10	700	700	470	470	134,00€
6027A801	CA016U	80 x 80/10	800	800	570	570	108,61€
6027A901	CA016V	90 x 90/10	900	900	670	670	181,21€

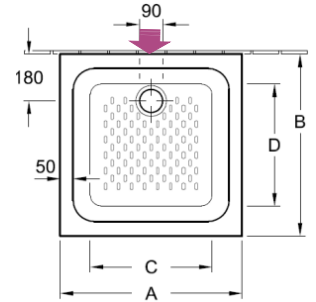

O'NOVO - RECEVEUR A POSER BLANC							
Référence	Code	Taille/Format	A	B	C	D	Prix public HT
6028A701	CA016Z	70 x 70/10	700	700	470	470	134,00€
6028A801	CA0170	80 x 80/10	800	800	570	570	108,61€
6028A901	CA0171	90 x 90/10	900	900	670	670	181,21€

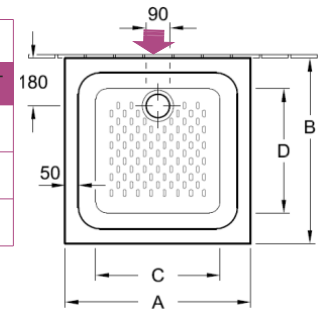
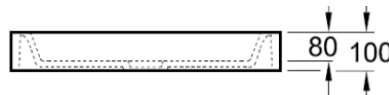

O'NOVO - RECEVEUR A POSER OU ENCASTRER BLANC							
Référence	Code	Taille/Format	A	B	C	D	Prix public HT
62158001	CA0173	80 x 80	800	800			223,00€
62219001	CA0179	90 x 90	900	900			289,00€

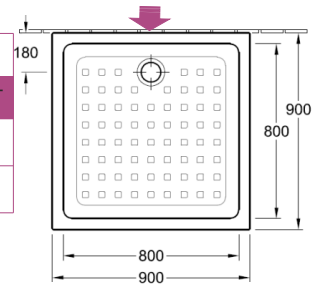
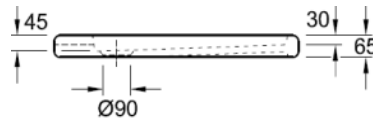

O'NOVO - RECEVEUR A POSER OU ENCASTRER BLANC AG							
Référence	Code	Taille/Format	A	B	C	D	Prix public HT
6221A901	CA019M	90 x 90	900	900			318,00€

\* Revêtement Antigloss

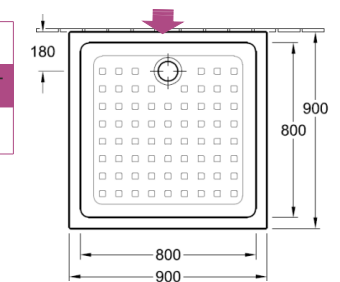
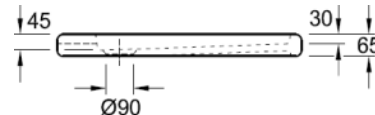

O'NOVO - RECEVEUR A POSER OU ENCASTRER BLANC AG							
Référence	Code	Taille/Format	A	B	C	D	Prix public HT
62221201	CA019I	120 x 80	1200	800			307,00€

\* Revêtement Antigloss

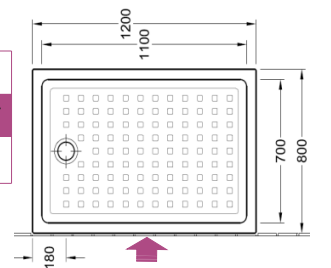
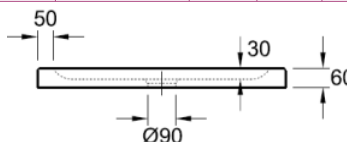

## → RECEVEURS O'NOVO

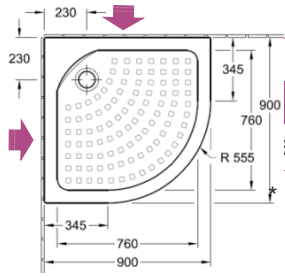

### O'NOVO - RECEVEUR 1/4 ROND A POSER OU ENCASTRER BLANC AG

Référence	Code	Taille/Format	A	B	C	D	Prix public HT
2099001	CA0172	90 x 90	900	900			244,00€

\* Revêtement Antigliss

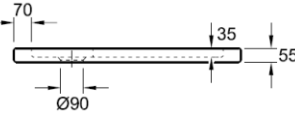

## → RECEVEURS LIFETIME

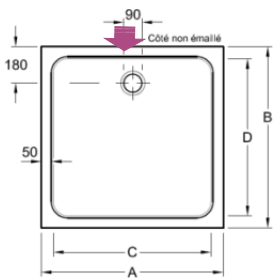

### LIFETIME - RECEVEUR A POSER OU ENCASTRER BLANC AG

Référence	Code	Taille/Format	A	B	C	D	Prix public HT
6031A901	CA0ABT	90 x 90	900	900	780	780	464,00€
6031A101	CA01I9	100 x 100	1000	1000	780	780	506,00€

\* Revêtement Antigliss

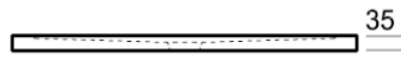

## → RECEVEURS SUBWAY

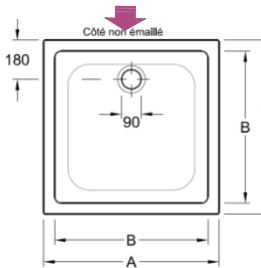

### SUBWAY - RECEVEUR A POSER OU ENCASTRER BLANC

Référence	Code	Taille/Format	A	B	C	D	Prix public HT
6035A801	CA01HP	80 x 80	800	700			342,00€
6035A901	CA017S	90 x 90	900	800			414,00€
6035A101	CA01HI	100 x 100	1000	900			476,00€

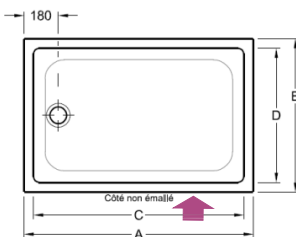
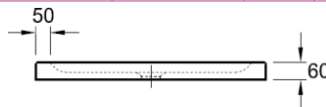

### SUBWAY - RECEVEUR A POSER OU ENCASTRER BLANC

Référence	Code	Taille/Format	A	B	C	D	Prix public HT
6013A001	CA018P	80 x 100	1000	800	900	700	517,00€
6013A101	CA017R	80 x 120	1200	800	1100	700	567,00€

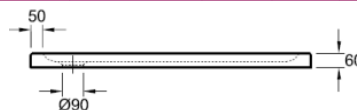



→ **RECEVEURS SUBWAY**



SUBWAY - RECEVEUR 1/4 ROND A POSER OU ENCASTRER BLANC							
Référence	Code	Taille/Format	A	B	C	D	Prix public HT
6036A901	CA017Q	90 x 90	900	800		350	433,00€

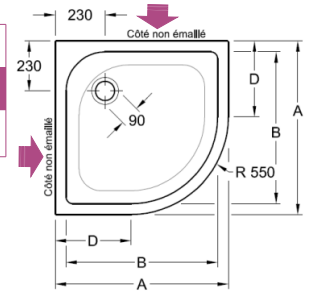
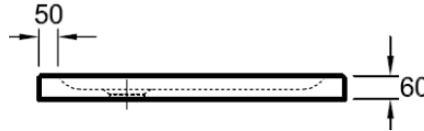

→ **RECEVEURS FUTURION**



FUTURION - RECEVEUR QUARYL A POSER OU ENCASTRER BLANC							
Référence	Code	Taille/Format	A	B	C	D	Prix public HT
DQ1280FFL2V-01	CA01DF	120 x 90	1200	900			484,00€
DQ1490FFL2V-01	CAKZC	140 x 90	1400	900			536,00€
DQ1690FFL2V-01	CA01DL	160 x 90	1600	900			608,00€

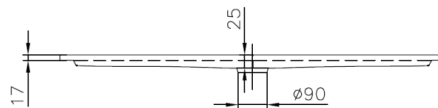

→ **RECEVEURS ULYSSE**



ULYSSE - RECEVEUR A POSER BLANC							
Référence	Code	Taille/Format	A	B	C	D	Prix public HT
P327501	C4455C	80 x 80	800	800			106,05€
P327601	C4455P	90 x 90	900	900			184,53€

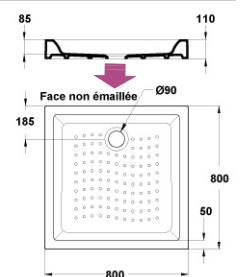

ULYSSE - RECEVEUR A ENCASTRER BLANC							
Référence	Code	Taille/Format	A	B	C	D	Prix public HT
P327201	C4455Q	80 x 80	800	800			106,05€
P327301	C4455R	90 x 90	900	900			184,53€

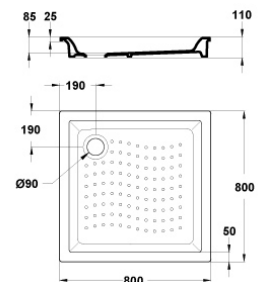



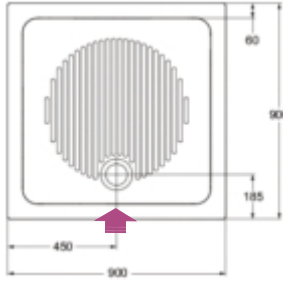

CONNECT - RECEVEUR A POSER BLANC							
Référence	Code	Taille/Format	A	B	C	D	Prix public HT
T266101	C00P22	80 x 80	800	800			190,50€
T266301	C00P23	90 x 90	900	900			255,70€



CONNECT - RECEVEUR A ENCASTRER BLANC							
Référence	Code	Taille/Format	A	B	C	D	Prix public HT
T266401	C00P24	80 x 80	800	800			190,50€
T266501	C00P25	90 x 90	900	900			255,70€

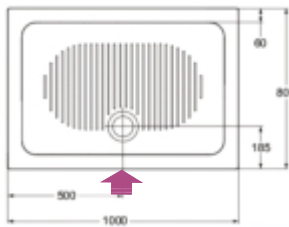
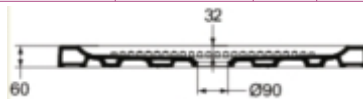

CONNECT - RECEVEUR A POSER OU ENCASTRER BLANC							
Référence	Code	Taille/Format	A	B	C	D	Prix public HT
T267801	C00P26	100 x 80	1000	800			300,70€
T268001	C00P27	120 x 90	1200	900			336,00€



→ **RECEVEURS FLAT**

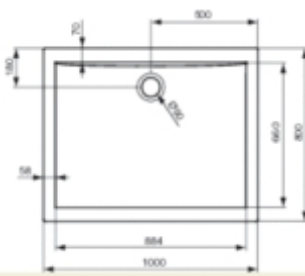

FLAT - RECEVEUR ACRYL ULTRA PLAT BLANC A POSER/ENCASTRER							
Référence	Code	Taille/Format	A	B	C	D	Prix public HT
K517301	C00P28	90 x 90	900	900			214,10€
K518001	C00P29	100 x 80	1000	800			265,20€
K518201	C00P2A	120 x 80	1200	800			265,20€

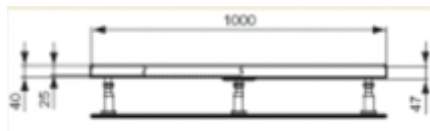

→ **Baignoires Bastia**



BASTIA - BAIGNOIRE BLANCHE							
Référence	Code	Taille/Format	A	B	C	D	Prix public HT
00091800000	C23046	160 x 70	1600	700			180,00€
00091600000	C23045	170 x 70	1700	700			180,00€
00062300000	C23044	170 x 75	1700	750			180,00€

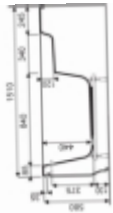

BASTIA - BAIGNOIRE D'ANGLE BLANCHE					
Référence	Code	Taille/Format			Prix public HT
0006540000	C23047	140 x 140	SANS TABLIER		411,00€
4065400000	C23048	140 x 140	AVEC TABLIER		840,00€

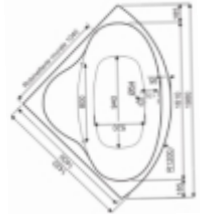

→ **Baignoires Prima Style**



PRIMA STYLE - BAIGNOIRE BLANCHE							
Référence	Code	Taille/Format	A	B	C	D	Prix public HT
00096700000	C00H4H	170 x 75	1700	750			393,00€
00097300000	C00HD0	180 x 80	1800	800			458,00€

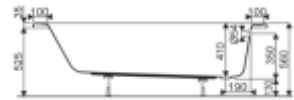
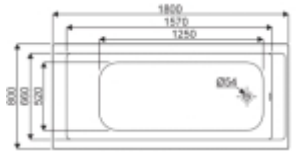

→ **Baignoires Volta**



VOLTA - BAIGNOIRE BLANCHE AVEC PIEDS							
Référence	Code	Taille/Format	A	B	C	D	Prix public HT
BT167CAAAW-01	CA0D76	160 x 70	1600	700			183,00€
BT177CAAAW-01	CA0D77	170 x 70	1700	700			183,00€
BT170CAAAW-01	CA0D78	170 x 75	1700	750			183,00€

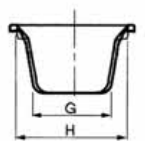
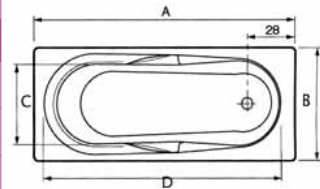



## → Baignoires Targa

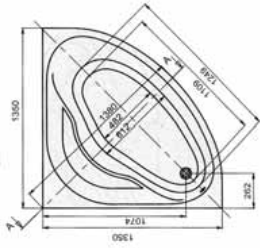

TARGA - BAIGNOIRE BLANCHE							
Référence	Code	Taille/Format	A	B	C	D	Prix public HT
BA170CLI2V-01	CA0D71	170 x 75	SANS PIEDS				271,00€
BA135LAG3V-01	CA0D73	135 x 135	ANGLE SANS PIEDS				367,00€



ACCESSOIRES DE BAIGNOIRES							
Référence	Code	Taille/Format	A	B	C	D	Prix public HT
BPA13502FP3-01	C11658		TABLIER DE BAIGNOIRE ANGLE TARGA				259,00€
40000000266	CA0D75		JEU DE PIED POUR TARGA				17,00€



## → Baignoires Ulysse

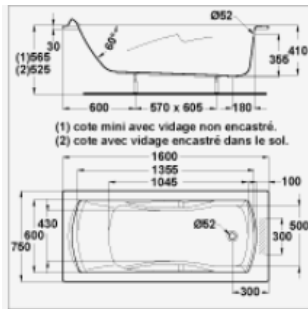

ULYSSE - BAIGNOIRE BLANCHE							
Référence	Code	Taille/Format	A	B	C	D	Prix public HT
P115801	C4455S	160 x 75	1600	750			203,00€
P115701	C4455T	170 x 75	1700	750			203,00€

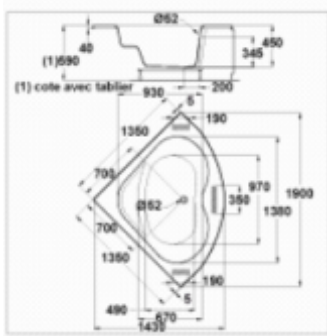

ULYSSE - BAIGNOIRE ANGLE BLANCHE							
Référence	Code	Taille/Format	A	B	C	D	Prix public HT
P107101	C00TKV	135 x 135					343,62€
P107201	C00TKX	TABLIER BAIGNOIRE ULYSSE ANGLE					239,53€



## → Baignoires Connect

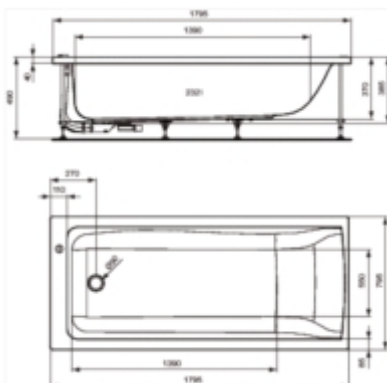

CONNECT - BAIGNOIRE BLANCHE (TABLIER EN OPTION)							
Référence	Code	Taille/Format	A	B	C	D	Prix public HT
E019601	C00P2B	170 x 75	1700	750			322,90€
E019801	C00P2C	180 x 80	1800	800			362,30€
R6075AA	C00P2D	VIDAGE AUTOMATIQUE					44,80€





BASTIA - VASQUE BLANCHE							
Référence	Code	Taille/Format	A	B	C	D	Prix public HT
00160000000	C61726	56 x 47	560	470			45,70€

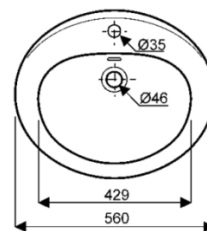
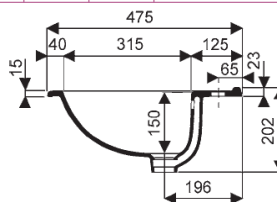

PRIMA - VASQUE BLANCHE							
Référence	Code	Taille/Format	A	B	C	D	Prix public HT
00152700000	C23144	60 x 47	600	470			198,00€

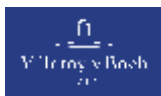
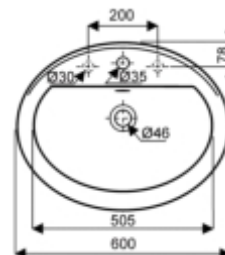
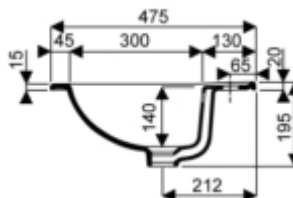

VOLTA - VASQUE BLANCHE							
Référence	Code	Taille/Format	A	B	C	D	Prix public HT
7G2285301	CA016J	53 x 44	530	440			46,47€

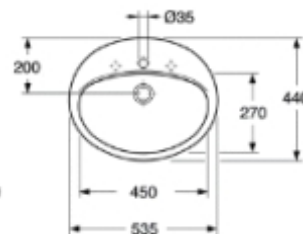

O'NOVO - VASQUE A POSER BLANCHE							
Référence	Code	Taille/Format	A	B	C	D	Prix public HT
41615601	CA01JQ	56 x 40	560	400			124,00€

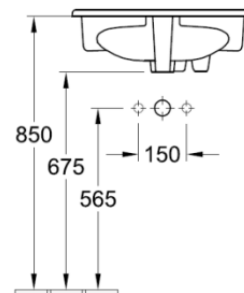
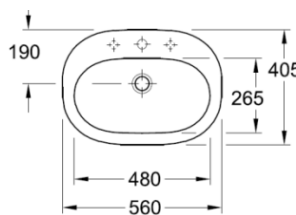

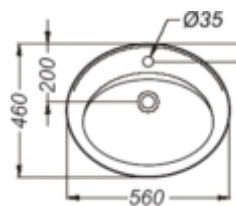

ULYSSE - VASQUE BLANCHE							
Référence	Code	Taille/Format	A	B	C	D	Prix public HT
P144801	C4455K	56 x 46	560	460			47,36€

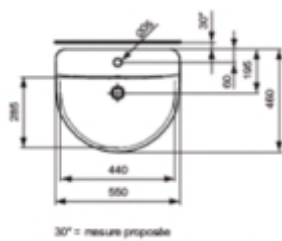
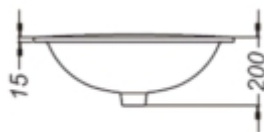

CONNECT - VASQUE BLANCHE							
Référence	Code	Taille/Format	A	B	C	D	Prix public HT
E797801	C00P1V	55 x 46		CONNECT ARC			135,10€
E804001	C00P1W	43 x 43		CONNECT SPHERE			135,10€

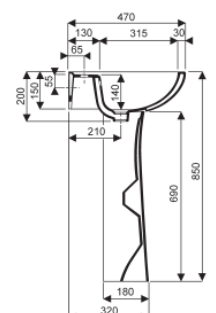
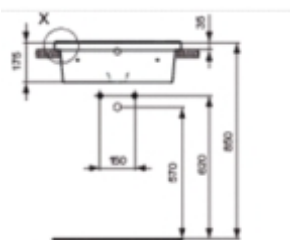

BASTIA - LAVABO COLONNE BLANC							
Référence	Code	Taille/Format	A	B	C	D	Prix public HT
00110000000	C23149	55		LAVABO			42,00€
00110500000	C23150	60		LAVABO			37,78€
00186200000	C23172			COLONNE			26,36€

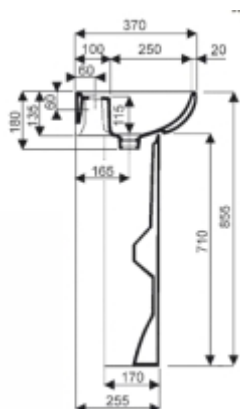
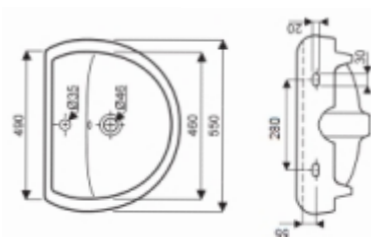

PRIMA - LAVABO COLONNE BLANC							
Référence	Code	Taille/Format	A	B	C	D	Prix public HT
00131300000	C2310F	50		LAVABO			86,00€
00133300000	C02310E	60		LAVABO			87,00€
00187300000	C2310G			COLONNE			68,00€

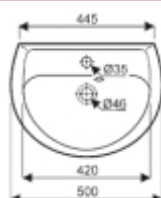
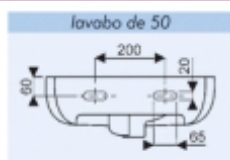



→ **LAVABOS COLONNE**



VOLTA - LAVABO COLONNE BLANC							
Référence	Code	Taille/Format	A	B	C	D	Prix public HT
7G206001	CA016E	60 x 49				LAVABO	37,67€
7G020001	CA016F					COLONNE	26,00€

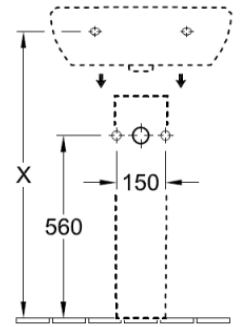

O'NOVO - LAVABO COLONNE BLANC							
Référence	Code	Taille/Format	A	B	C	D	Prix public HT
5160600	CA01JI	60 x 49				LAVABO	86,00€
52650001	CA01JL					COLONNE	60,00€

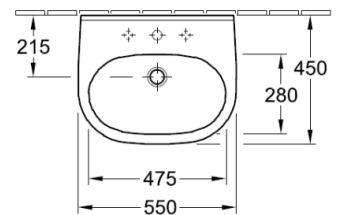

→ **LAVABOS COLONNE**



ULYSSE - LAVABO COLONNE BLANC							
Référence	Code	Taille/Format	A	B	C	D	Prix public HT
P125601	C44559	60 x 47	600	470			37,46€
P204201	C4455A					COLONNE	25,83€

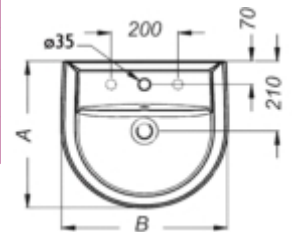

CONNECT - LAVABO COLONNE BLANC							
Référence	Code	Taille/Format	A	B	C	D	Prix public HT
E713501	C00P1S	60 x 46				LAVABO ARC	94,70€
E714101	C00P1T	60 x 46				LAVABO CARRE	94,70€
E711201	C00P1U					COLONNE	70,90€

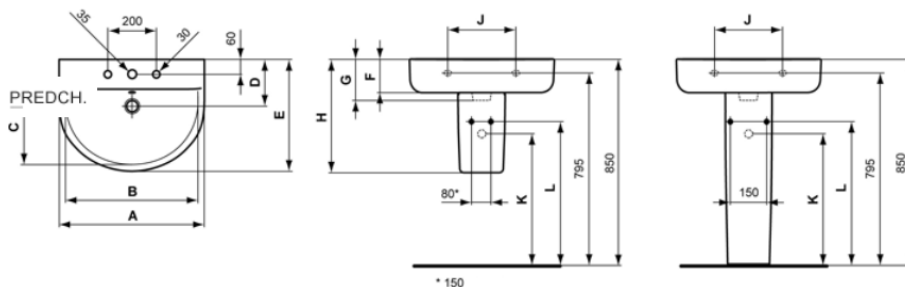

PRIMA - BIDET BLANC							
Référence	Code	Taille/Format	A	B	C	D	Prix public HT
00205000000	C23177						135,00€

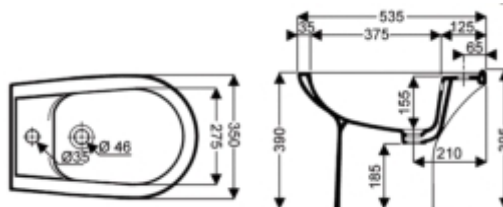

VOLTA - BIDET BLANC							
Référence	Code	Taille/Format	A	B	C	D	Prix public HT
7G400001	CA016I						72,00€



VOLTA - RÉSERVOIR EQUIPE 3/6L BLANC				
Référence	Code	Taille		Prix public HT
7G762101	CA016H			62,10€



PRIMA - RÉSERVOIR EQUIPE 3/6L BLANC SILENCIEUX				
Référence	Code	Taille		Prix public HT
00376500000806	C72586			141,00€



→ WC A POSER BASTIA



BASTIA - CUVETTE ET RÉSERVOIR INDÉPENDANT BLANC				
Référence	Code	Taille/Format		Prix public HT
00347500000	C23206	CUVETTE SH SANS ABATTANT		54,47€
00382510000360	C23214		RÉSERVOIR	73,36€
00382510000463	C04992	RÉSERVOIR 3/6 L.		60,63€

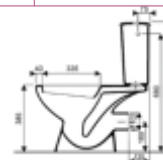
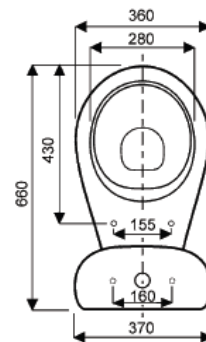

BASTIA - CUVETTE SURÉLEVÉ ET RÉSERVOIR INDÉPENDANT BLANC				
Référence	Code	Taille		Prix public HT
00328000000	C23204		CUVETTE SURÉLEVÉ SH SEULE SANS ABATTANT	115,98€
00376500000806	C72586		RÉSERVOIR EQUIPE 3/6 L.SILEN.	61,51€

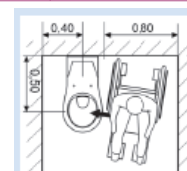
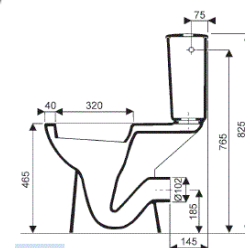

→ WC A POSER PUBLICA



PUBLICA - CUVETTE ALIMENTATION INDIVIDUELLE BLANCHE				
Référence	Code	Taille		Prix public HT
00300000000	C23192		CUVETTE SORTIE VERTICAL SANS ABATTANT	104,00€
00309000000	C2321A		CUVETTE SORTIE HORIZONTALE	78,00€

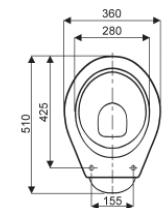
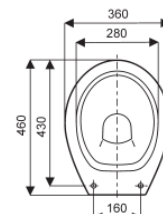
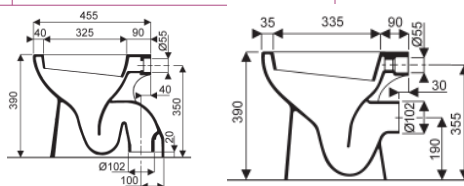

PUBLICA - CUVETTE SURÉLEVÉE ALIMENTATION INDV. BLANCHE				
Référence	Code	Taille		Prix public HT
00315500000	C23197		CUVETTE SURÉLEVÉE SANS ABATTANT	195,00€

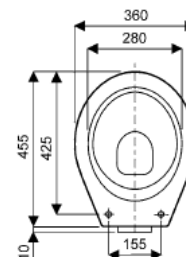
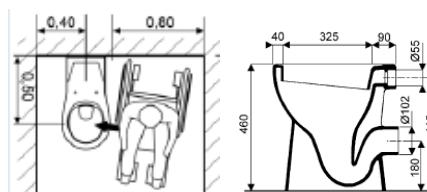



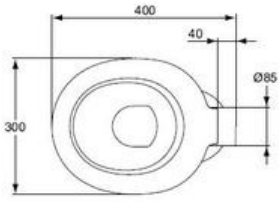

MATERNELLE - CUVETTE INDÉPENDANTE SH BLANCHE			
Référence	Code	Taille	Prix public HT
P256401	C4456F	CUVETTE INDEPENDANTE SH	160,60€

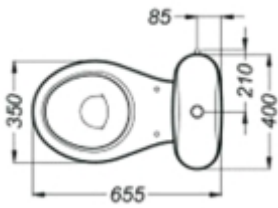
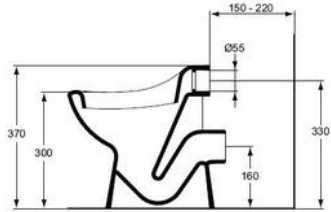

ULYSSE - CUVETTE ET RÉSERVOIR INDÉPENDANT BLANCHE			
Référence	Code	Taille	Prix public HT
P238501	C4455H	CUVETTE SH SANS ABATTANT	55,97€
P929801	C4455I	RÉSERVOIR	64,70€

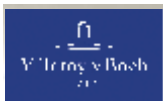
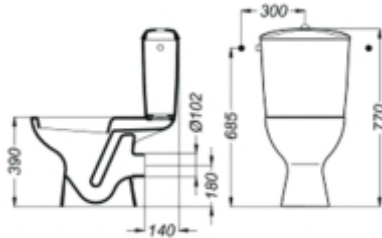



BASTIA - CUVETTE SUSPENDUE SEULE BLANCHE				
Référence	Code	Taille		Prix public HT
00396700000	C23217		CUVETTE SUSPENDUE SEULE	61,51€

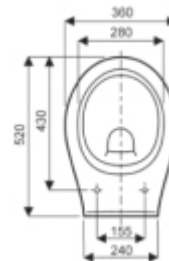
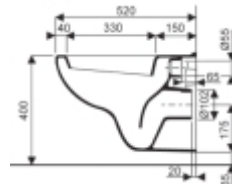
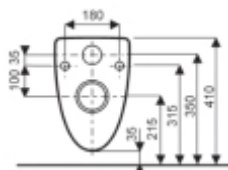

PRIMA - CUVETTE SUSPENDUE SEULE BLANCHE				
Référence	Code	Taille		Prix public HT
00392300000	C2310I		CUVETTE SUSPENDUE SEULE	130,00€

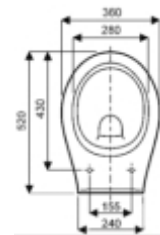
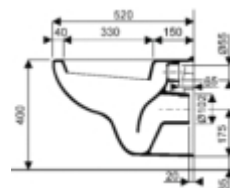
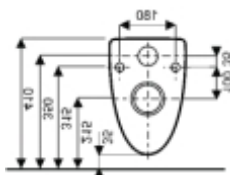

PRIMA - CUVETTE SUSPENDUE COURTE BLANCHE				
Référence	Code	Taille		Prix public HT
00390300000	C2310J		CUVETTE SUSPENDUE COURTE	130,00€
00046300000	C2310K		ABATTANT COURT DOUBLE BLANC	47,00€

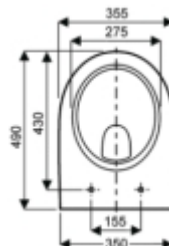

PRIMA STYLE - PACK WC SUSPENDU BLANC				
Référence	Code	Taille		Prix public HT
8395300000100	C00H4I		PACK WC SUSPENDU AVEC ABATTANT	273,00€

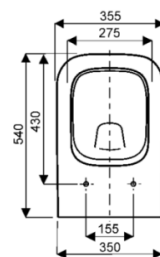
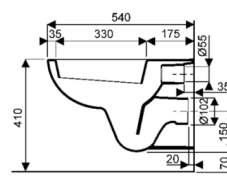
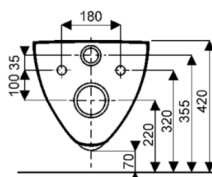

ALOE - CUVETTE SUSPENDUE CARENEE BLANCHE				
Référence	Code	Taille		Prix public HT
08398400000100	C7572J		AVEC ABATTANT FREIN DE CHUTE	326,09€

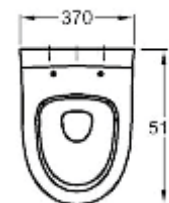
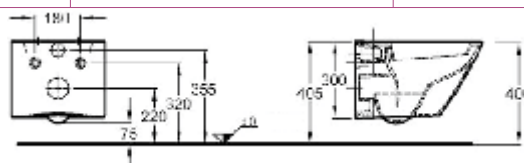



VOLTA - CUVETTE SUSPENDUE BLANCHE			
Référence	Code	Taille	Prix public HT
7G651001	CA016L		CUVETTE SUSPENDUE FOND CREUX SANS ABATTANT 69,93€

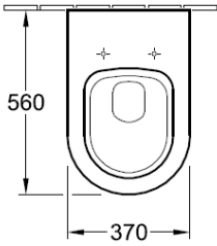

TARGA ARCHITECTURA - CUVETTE SUSPENDUE BLANCHE			
Référence	Code	Taille	Prix public HT
56741001	CA01CC		CUVETTE SUSPENDUE 209,00€
98M96101	CA01IM		ABATTANT CUVETTE TARGA 87,00€

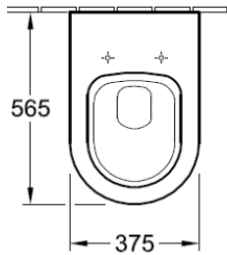
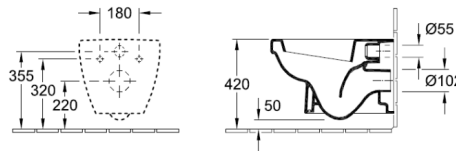

SUBWAY - CUVETTE SUSPENDUE BLANCHE			
Référence	Code	Taille	Prix public HT
66001001	CA02RZ		CUVETTE SUSPENDUE 309,00€
99556101	C000EI		ABATTANT CUVETTE SUSPEND. 110,00€

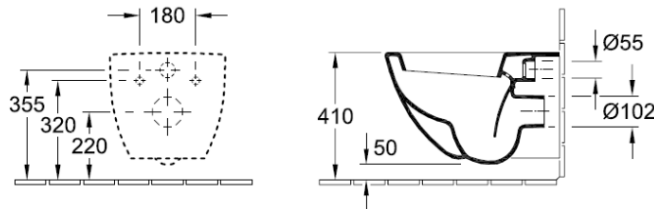



ULYSSE - CUVETTE SUSPENDUE BLANCHE			
Référence	Code	Taille	Prix public HT
P244501	C4455N		CUVETTE SUSPENDUE SANS ABATTANT 72,45€

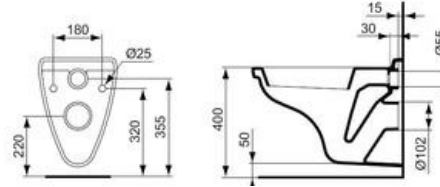
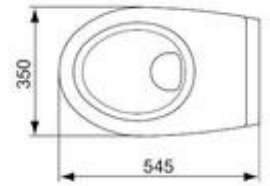

CONNECT - CUVETTE SUSPENDUE BLANCHE			
Référence	Code	Taille	Prix public HT
E711601	C00P1Z		CUVETTE SUSPENDUE AVEC ABATTANT FREIN DE CHUTE 200,80€

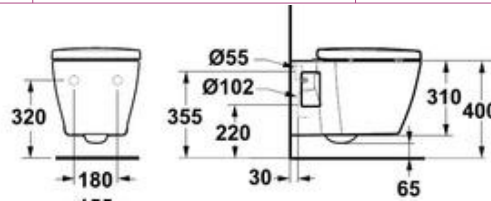
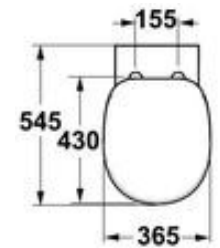

MATURA 2 - CUVETTE SUSPENDUE RALLONGÉE BLANCHE			
Référence	Code	Taille	Prix public HT
P243001	C4455Y		CUVETTE SUSPENDUE RALLONGEE 162,50€
P504201	C4455W		ABATTANT DOUBLE 63,70€

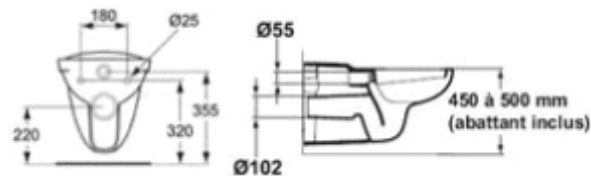
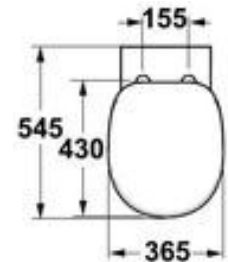

ESCAPULADE - CUVETTE SUSPENDUE ERGONOMIQUE BLANCHE			
Référence	Code	Taille	Prix public HT
P259201	C4455Y		CUVETTE SUSPENDUE ERGONOMIQUE SANS ABATTANT 162,50€

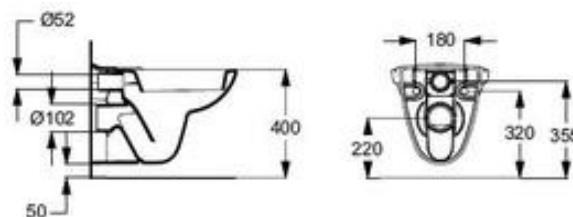
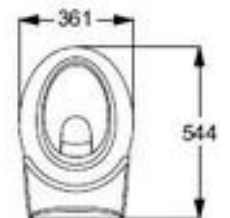

**FLASH - PACK WC SH BLANC**

Référence	Code	Taille	Prix public HT
08331500000102	C7572I	PACK WC SH	121,80€

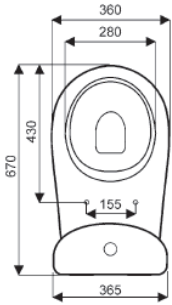

**DITO - PACK WC SH BLANC**

Référence	Code	Taille	Prix public HT
8322900000200	C7572G	PACK WC SH	199,00€

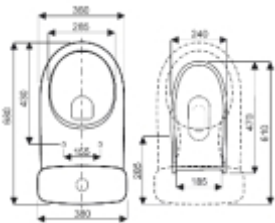
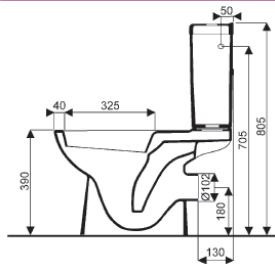

**PRIMA - PACK WC SH BLANC**

Référence	Code	Taille	Prix public HT
8322300000200	C0544E	PACK WC SH	263,00€

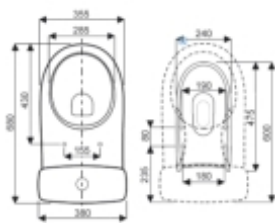
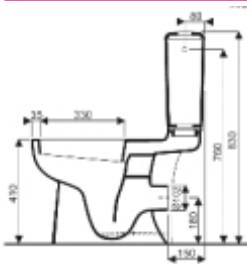

**PRIMA - PACK WC SURÉLEVÉ SH BLANC**

Référence	Code	Taille	Prix public HT
8311300000200	C0544F	PACK WC SURELEVE SH	394,00€

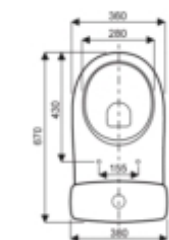
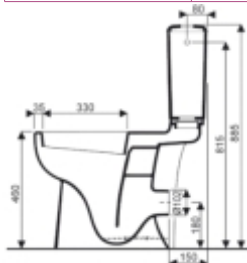

**PRIMA MULTI - PACK WC SH BLANC**

Référence	Code	Taille	Prix public HT
08324300000200	C0544G	PACK WC SH	383,00€

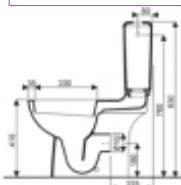



PRIMA MULTI COMPACT - PACK WC BLANC				
Référence	Code	Taille		Prix public HT
08331300000200	C0544K		PACK WC	383,00€

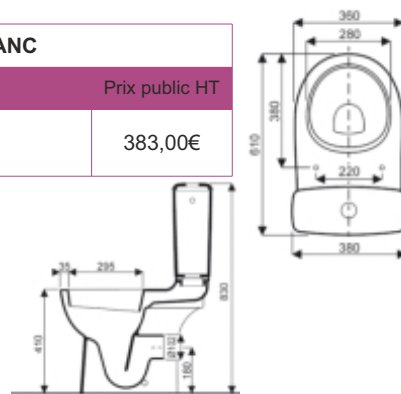

PRIMA MULTI COMPACT - PACK WC ANGLE BLANC				
Référence	Code	Taille		Prix public HT
08331400000200	C6603A		PACK WC ANGLE	438,00€

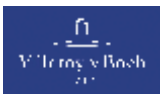
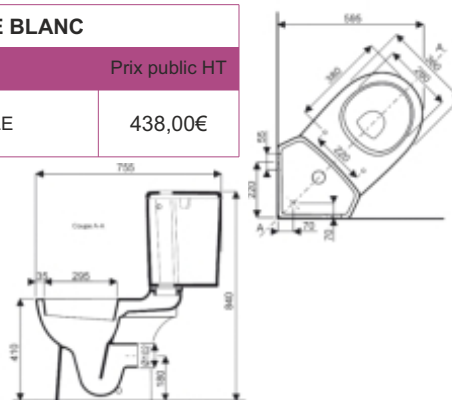

ALFOLDI - PACK WC BLANC				
Référence	Code	Taille		Prix public HT
4045H401	CA05G4		PACK WC SH	121,80€



O'NOVO - PACK WC BLANC				
Référence	Code	Taille		Prix public HT
5661H101	CA01K6		PACK WC SORTIE HORIZONTALE AVEC ABATTANT FREIN DE CHUTE	289,00€
5661V101	CA01K7		PACK WC SORTIE VERTICALE AVEC ABATTANT FREIN DE CHUTE	355,00€

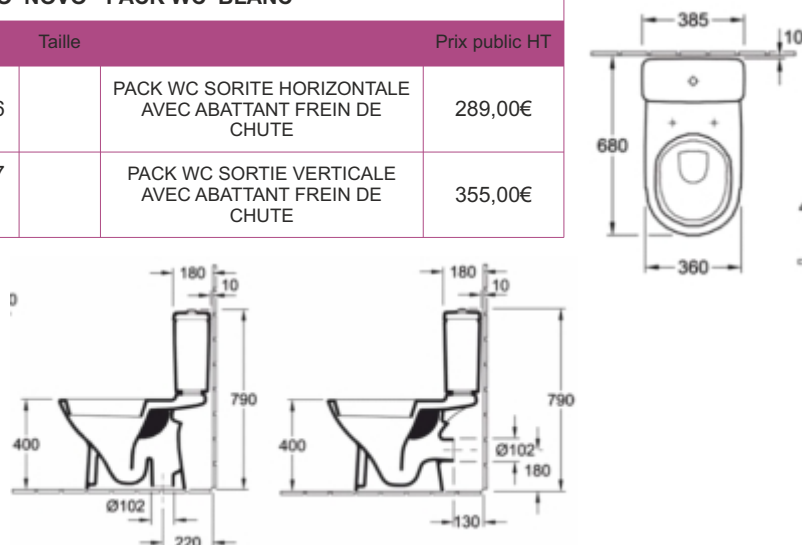

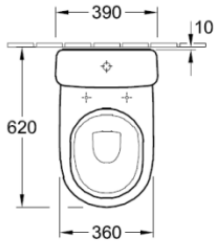

O 'NOVO - PACK WC SH COMPACT BLANC			
Référence	Code	Taille	Prix public HT
5689H101	CA01K9	PACK WC SH AVEC ABATTANT FREIN DE CHUTE	386,00€

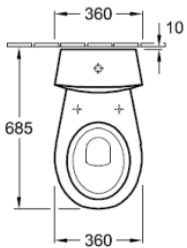
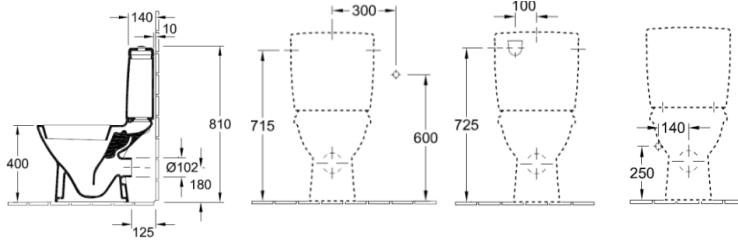

TARGA VITA - PACK WC SH SURÉLEVÉ BLANC			
Référence	Code	Taille	Prix public HT
7623H701	CA09J2	PACK WC SH SURELEVE	417,00€

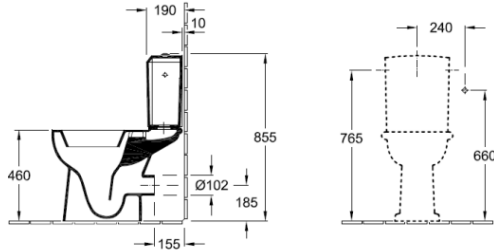

TARGA ARCHITECTURA - PACK WC SH BLANC			
Référence	Code	Taille	Prix public HT
5677H701	CA01C1	PACK WC SH	394,00€

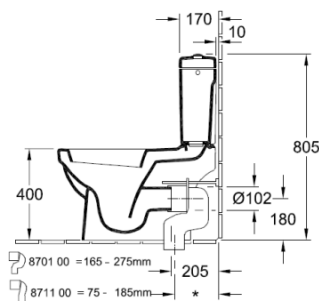



Pack WC NOE blanc sans bidet

NOE - PACK WC SH BLANC				
Référence	Code	Taille		Prix public HT
P948001	C4455M		PACK WC SH	114,45€



ULYSSE - PACK WC SH SURÉLEVÉ BLANC				
Référence	Code	Taille		Prix public HT
P946201	C4455X		PACK WC SH SURELEVE	238,80€

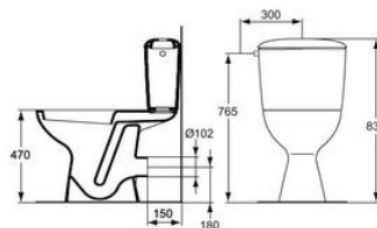
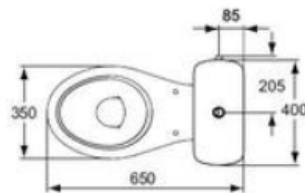

CLASSIC - PACK WC SH BLANC				
Référence	Code	Taille		Prix public HT
E716901	C00P21		PACK WC SH	281,50€

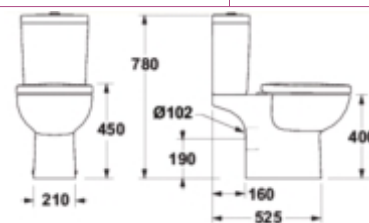
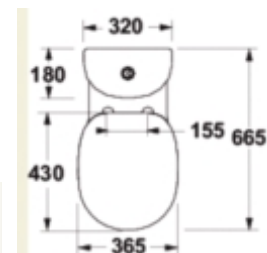

CONNECT - PACK WC SH BLANC				
Référence	Code	Taille		Prix public HT
E715401	C00P20		PACK WC SH	325,00€

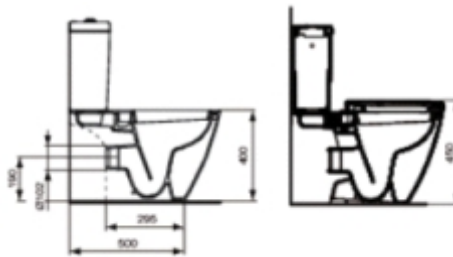
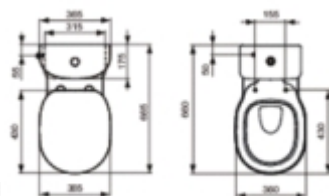







→ **BATI SUPPORT**



BCU - PACK WC SUSPENDU CHANTIER				
Référence	Code	Taille		Prix public HT
31226110	C0544L		PACK WC SUSPENDU CHANTIER 2 COLIS	296,70€

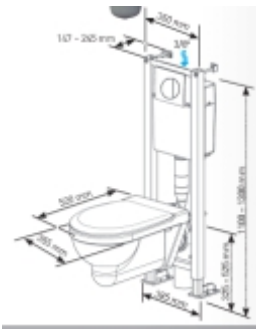

→ **LAVE MAINS**



BASTIA - LAVE MAINS BLANC				
Référence	Code	Taille		Prix public HT
00104500000	C65475	45 x 32	LAVE MAINS BLANC	42,00€

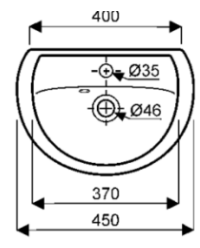
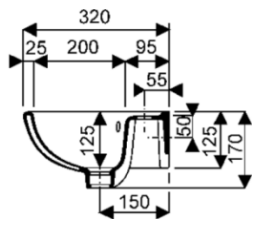

PRIMA - LAVE MAINS BLANC				
Référence	Code	Taille		Prix public HT
00101400000	C2310M	45 x 40	LAVE MAINS BLANC	90,00€

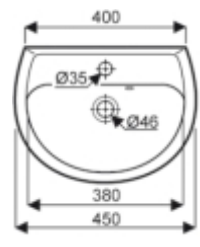
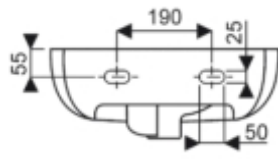

PRIMA COMPACT - LAVE MAINS BLANC				
Référence	Code	Taille		Prix public HT
00102400000	C2329B	53 x 26	LAVE MAINS COMPACT BLANC	99,00€

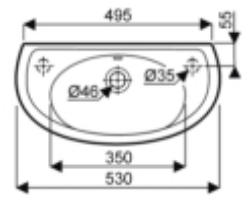
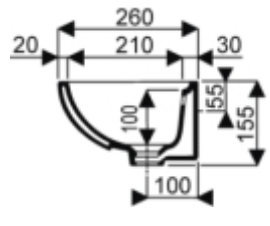



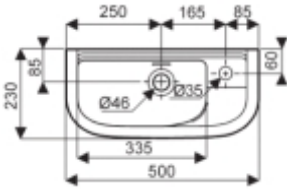

LINEA - LAVE MAINS BLANC				
Référence	Code	Taille		Prix public HT
00109000000	C23090		LAVE MAINS BLANC	106,00€

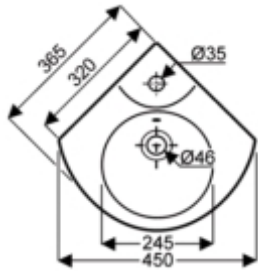
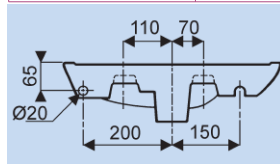

PRIMA - LAVE MAINS D'ANGLE BLANC				
Référence	Code	Taille		Prix public HT
00100200000	C23096		LAVE MAINS D'ANGLE BLANC	98,00€

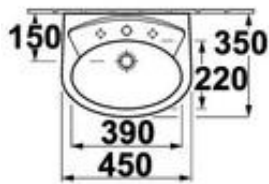
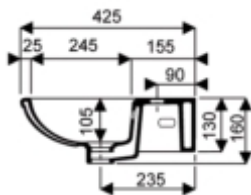

VOLTA - LAVE MAINS BLANC				
Référence	Code	Taille		Prix public HT
7G354501	CA016K	45 x 35	LAVE MAINS BLANC	45,00€

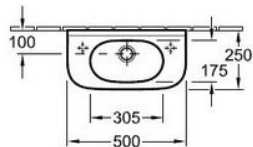
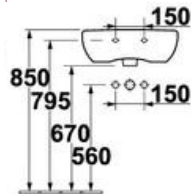

O'NOVO - LAVE MAINS BLANC				
Référence	Code	Taille		Prix public HT
53615001	CA01JT	50 x 25	LAVE MAINS BLANC	96,00€

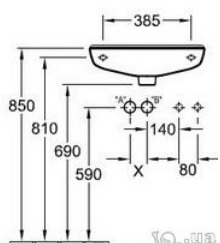
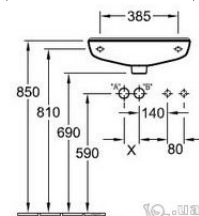

O'NOVO - LAVE MAINS BLANC				
Référence	Code	Taille		Prix public HT
53605001	CA01JU	50 x 40	LAVE MAINS BLANC	92,00€

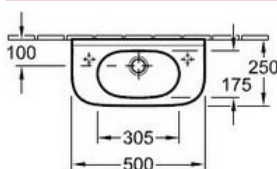



→ LAVE MAINS



O'NOVO - LAVE MAINS D'ANGLE BLANC				
Référence	Code	Taille		Prix public HT
73274001	CA0177		LAVE MAINS D'ANGLE BLANC	116,00€

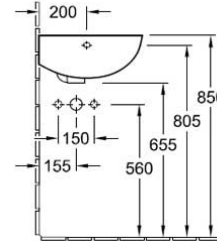
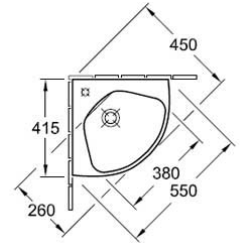

→ LAVE MAINS



ULYSSE - LAVE MAINS BLANC				
Référence	Code	Taille		Prix public HT
E899701	C44570	34 x 34	LAVE MAINS D'ANGLE BLANC	51,00€
E899101	C4457K	45 x 35	LAVE MAINS D 'ANGLE BLANC	41,50€

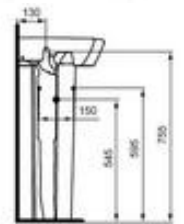
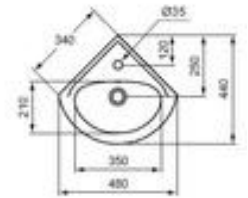

CONNECT - LAVE MAINS ARC BLANC				
Référence	Code	Taille		Prix public HT
E791201	C00P1X	35 x 26	LAVE MAINS ARC BLANC	86,90€

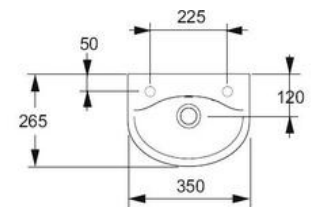

CONNECT - LAVE MAINS CUBE BLANC				
Référence	Code	Taille		Prix public HT
E713701	C00P1Y	35 x 26	LAVE MAINS CUBE BLANC	88,00€

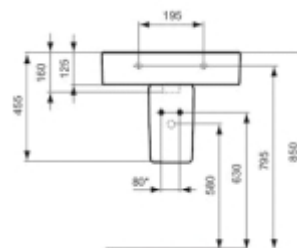
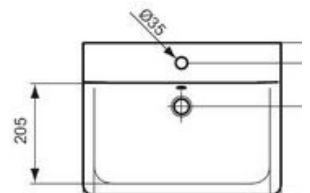

VALLAURIS - EVIER GRES 2 BACS A ENCASTRER				
Référence	Code	Taille		Prix public HT
00680000000	C23243	112 x 50	EVIER A ENCASTRER BLANC 2 BACS	231,00€

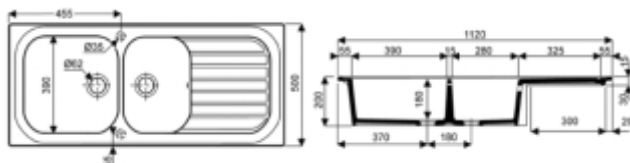

VALLAURIS - EVIER GRES 1 BAC A ENCASTRER				
Référence	Code	Taille		Prix public HT
00681000000	C23248	92 x 50	EVIER A ENCASTRER BLANC 1 BAC	217,00€

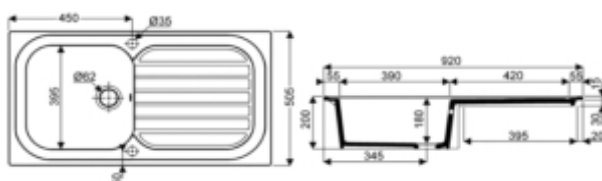

ROANNE - EVIER GRES 2 BACS / 2 EGOUTTOIRS A POSER BLANC				
Référence	Code	Taille		Prix public HT
00691000000	C62020	140 x 60	EVIER A POSER BLANC 2 BACS / 2 EGOUTTOIRS	509,00€

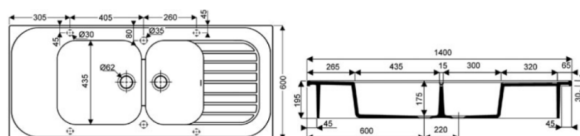

ROMANS - EVIER GRES 2 BACS / 1 EGOUTTOIR A POSER BLANC				
Référence	Code	Taille		Prix public HT
00690000000	C23253	120 x 60	EVIER A POSER BLANC 2 BACS / 1 EGOUTTOIR	152,38€

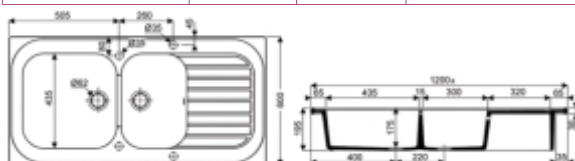

REDON - EVIER GRES 1 BAC / 1 EGOUTTOIR A POSER BLANC				
Référence	Code	Taille		Prix public HT
00692000000	C62023	100 x 60	EVIER A POSER BLANC 1 BAC / 1 EGOUTTOIR	191,00€

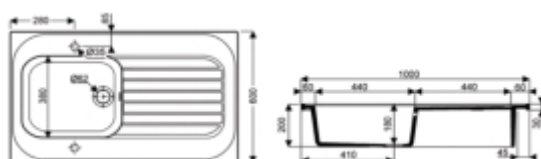



ROYAT - EVIER GRES A POSER 1 BAC / 1 EGOUTTOIR BLANC				
Référence	Code	Taille		Prix public HT
00694000000	C62033		EVIER A POSER BLANC 1BAC / 1 EGOUTTOIR SPÉCIAL LAVE VAISSELLE	361,00€

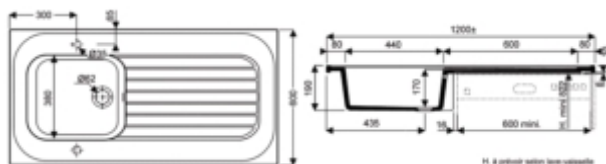

PUBLICA - EVIER D'APPOINT A POSER BANDEAU 13 CM - BLANC							
Référence	Code	Taille/Format	A	B	C	D	Prix public HT
00500000000	C23221	50 x 40	500	400	460	360	137,00€

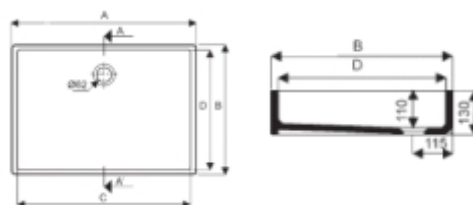

PUBLICA - EVIER D'APPOINT A POSER BANDEAU 20 CM - BLANC								
Référence	Code	Taille/Format	A	B	C	D	E	Prix public HT
00523000000	C23225	70 x 50	700	500	655	430	140	246,00€
00521000000	C23224	60 x 50	600	500	565	430	130	246,00€

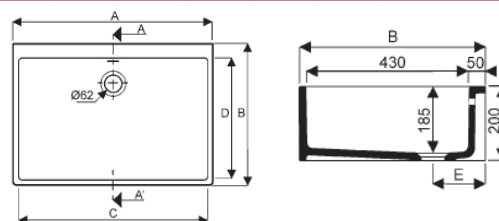

NESTOR - EVIER GRES A ENCASTRER 2 BACS / 1 EGOUTTOIR BLANC				
Référence	Code	Taille		Prix public HT
67510301	CA0160	112 x 51	EVIER A POSER BLANC 1BAC / 1 EGOUTTOIR	171,89€

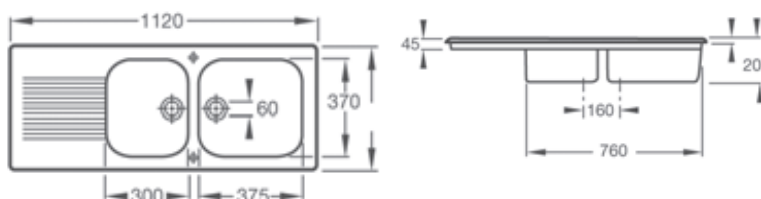

TUDOR - EVIER GRES A ENCASTRER 1 BAC BLANC				
Référence	Code	Taille		Prix public HT
67610301	CA017B	92 x 51	EVIER GRES A ENCASTRER 1 BAC BLANC	162,06€

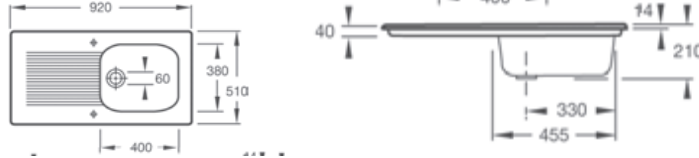

WINDSOR - EVIER GRES A POSER 2 BACS / 1 ÉGOUTTOIR BLANC				
Référence	Code	Taille		Prix public HT
67270301	CA016M	92 x 51	EVIER GRES A ENCASTRER 1 BAC BLANC	138,03€

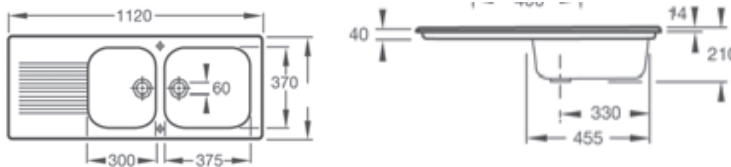

MOGADOR - EVIER GRES A POSER 1 BAC BLANC				
Référence	Code	Taille		Prix public HT
67380301	CA016N	92 x 51	EVIER GRES A ENCASTRER 1 BAC BLANC	151,62€

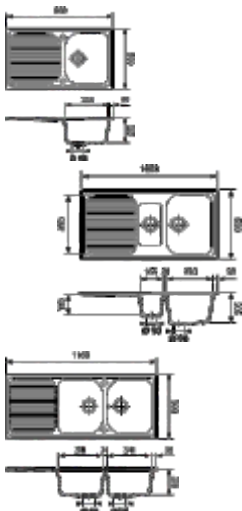
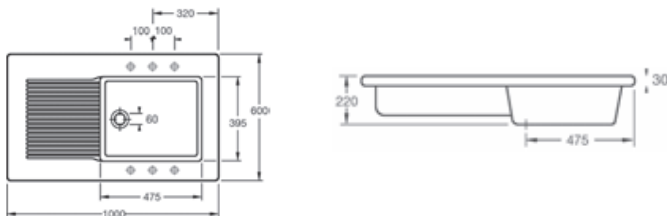

EVIER RESINE				
Référence	Code	Taille		Prix public HT
EV501111	C09415	860 x 500	OSLO 1 BAC / 1 EGOUTTOIR TOPGRANIT LAVA	208,19€
EV511111	C09412	1000 x 500	COPENHAGUE 1 BAC 1/2 / 1 EGOUTTOIR TOPGRANIT LAVA	216,56€
EV502111	C09409	860 x 500	STOCKHOLM 2 BACS / 1 EGOUTTOIR TOPGRANIT LAVA	224,92€
EV502051	C14684	1160 x 500	STOCKHOLM 2 BACS / 1 EGOUTTOIR TOPGRANIT PERA	224,92€
EV502110	C04899	1160 x 500	STOCKHOLM 2 BACS / 1 EGOUTTOIR TOPGRANIT PERA	224,92€





EVIER INOX A POSER				
Référence	Code	Taille		Prix public HT
EPAZ080A01	C10773	80 x 60	EVIER INOX A POSER 1 BAC	97,90€
EPAZ090A01	C10774	90 x 60	EVIER INOX A POSER 1 BAC	97,90€
EPAZ100A01	C10775	100 x 60	EVIER INOX A POSER 1 BAC / 1 EGOUTTOIR	97,90€
EPAZ120A01	C10776	120 x 60	EVIER INOX A POSER LV 1 BAC / 1 EGOUTTOIR	102,30€
EPBZ120A01	C10777	120 x 60	EVIER INOX A POSER 2 BACS / 1 EGOUTTOIR	84,00€
EPBV140A01	C10780	140 x 60	EVIER INOX A POSER LV 2 BACS / 2 EGOUTTOIRS	145,20€

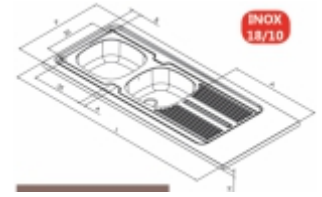

	INOX	REFERENCES	DIMENSIONS L x P x H /cm	COTES		CUVE	Poids Brut Kg	Collisage		
				A/cm	B/cm					
Cuves soudées	LISSE	EPAZ080A01	80 x 60 x 3	40	5	1 x 15 L	4,80	1		
		EPAZ090A01	90 x 60 x 3	50			5,30			
		EPAZ100A01	100 x 60 x 3	60			5,70			
		EPAZ120A01	120 x 60 x 3	80			6,80			
	TOILE	EPBZ120A01	120 x 60 x 3	41	6	1 x 15 L	7,20			
		EPBV140A01	140 x 60 x 3	61			2 x 15 L		7,90	
		EPAZ120G01	120 x 60 x 3	80			6		1 x 15 L	6,00
		EPBZ120G01	120 x 60 x 3	42			5		2 x 15 L	6,50
Monobloc	LISSE	EPBM120A05	120 x 60 x 5	42	5	2 x 14 L	6,10	1		
		EPBZ140G01	140 x 60 x 3	64	5	2 x 15 L	7,70			



EVIER INOX A ENCASTRER				
Référence	Code	Taille		Prix public HT
EECS047A00	C1077E	49 x 49	EVIER INOX A ENCASTRER 1 BAC	113,30€

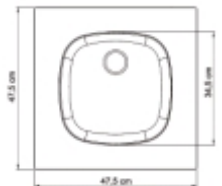

EVIER INOX A ENCASTRER				
Référence	Code	Taille		Prix public HT
EEAM086A01	C1077J	86 x 44	EVIER INOX A ENCASTRER 1 BAC / 1 EGOUTTOIR	113,30€

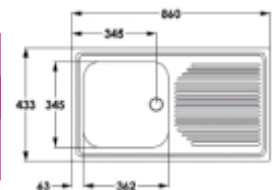

EVIER INOX A ENCASTRER				
Référence	Code	Taille		Prix public HT
EEBM116A01	C1077L	116 x 50	EVIER INOX A ENCASTRER 2 BACS / 1 EGOUTTOIR	158,40€

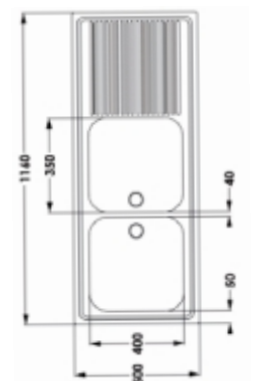

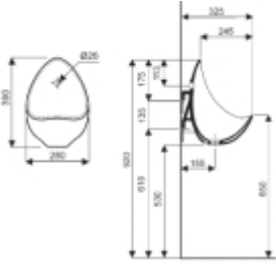

AUBAGNE - URINOIR BLANC				
Référence	Code	Taille		Prix public HT
00363900000100	C23498		URINOIR BLANC	82,00€
00026000	C14408		PATTES DE MONTAGE ANGLE	19,00€

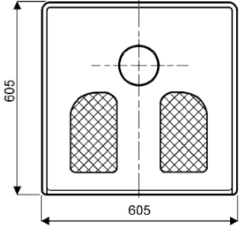

SIÈGE TURC				
Référence	Code	Taille		Prix public HT
00723000000	C23288		SIEGE TURC	124,00€

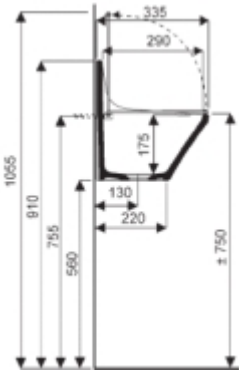
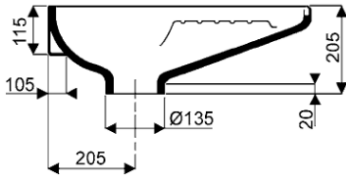

DÉVERSOIR MURAL				
Référence	Code	Taille		Prix public HT
00475000000	C22992		DÉVERSOIR MURAL	200,00€

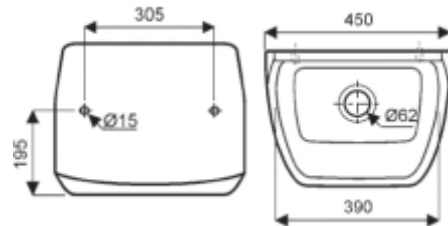

CUVE A LAVER				
Référence	Code	Taille		Prix public HT
00561000000	C23226		CUVE A LAVER	363,00€

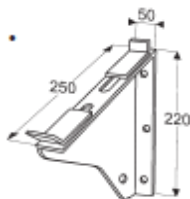
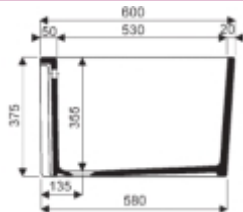

LAVABO COLLECTIF				
Référence	Code	Taille		Prix public HT
00762000000	C23298	100 x 38	LAVABO COLLECTIF	178,00€
00766000000	C23299		DOSSERET	91,00€
00029800000	C14409		PAIRE DE CONSOLES	54,00€

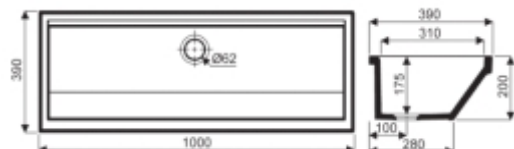
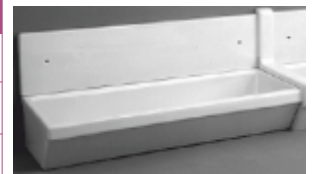





PUBLICA - CUVETTE SUSPENDUE BLANCHE			
Référence	Code	Taille	Prix public HT
00391500000	C58599	CUVETTE SUSPENDUE BLANCHE	155,00€

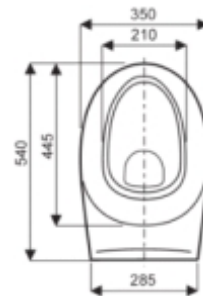
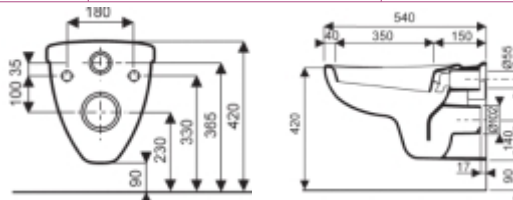

PARACELTUS - CUVETTE SUSPENDUE BLANCHE			
Référence	Code	Taille	Prix public HT
00392200000	C14426	CUVETTE SUSPENDUE BLANCHE	244,00€

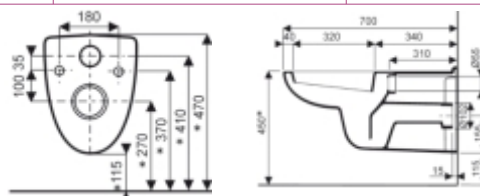

CUVETTE BÉBÉ BLANCHE			
Référence	Code	Taille	Prix public HT
00314000000	C23195	CUVETTE BÉBÉ	124,00€

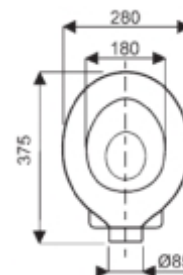
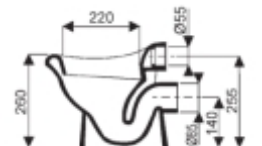

PUBLICA - CUVETTE ALIMENTATION INDÉPENDANTE BLANCHE			
Référence	Code	Taille	Prix public HT
00315500000	C23197	CUVETTE ALIMENTATION INDÉPENDANTE SH	195,00€

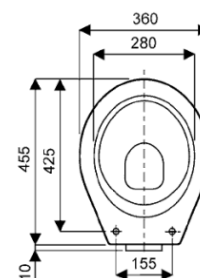
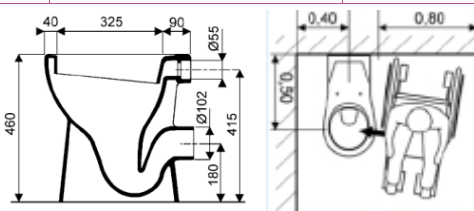

PARACELTUS - LAVABO BLANC				
Référence	Code	Taille	Prix public HT	
00119500000	C2310D	65 x 56	LAVABO BLANC	196,00€
00029100017	C22998		BONDE VIDAGE DÉCALÉE	54,00€

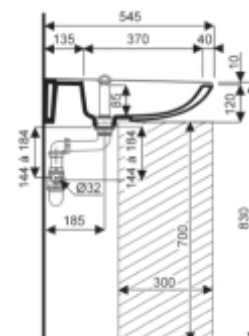
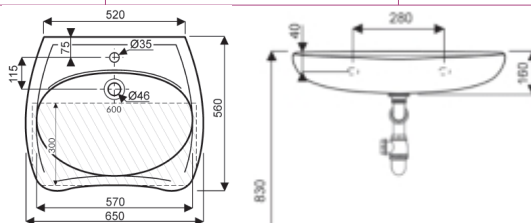



MATURA - LAVABO BLANC				
Référence	Code	Taille		Prix public HT
S221901	C4455U	60 x 55	LAVABO BLANC	206,00€

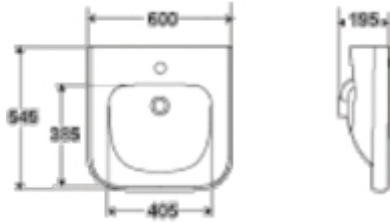

LAVABO AUGE BLANC				
Référence	Code	Taille		Prix public HT
P310001	C44561	95 x 33	LAVABO AUGE BLANC	190,40€
D5706AC	C44562		SACHET DE CONSOLE	27,10€

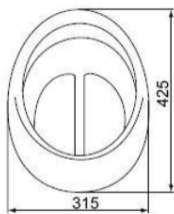
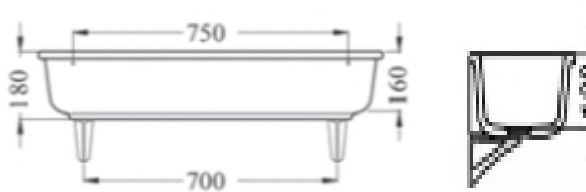

PACK URINOIR				
Référence	Code	Taille		Prix public HT
S612401	C44564	95 x 33	PACK URINOIR ANTI ECLABOUSSURES	138,20€



BACS A USAGE MULTIPLE				
Référence	Code	Taille		Prix public HT
1TPB55035	C4519A	55 x 39	BLANC MARBRE	66,05€
1TPB65035	C45199	65 x 45	BLANC MARBRE	93,65€
1SUB5000	C45198	65	MEUBLE SOUS BAC BLANC	188,13€





ULYSSE - MÉLANGEUR LAVABO				
Référence	Code	Taille/Format		Prix public HT
D1603AA	C44578		AVEC VIDAGE	60,10€

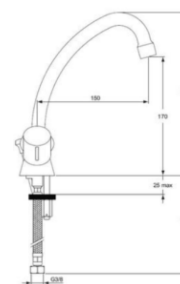

ULYSSE - MÉLANGEUR BAIN DOUCHE MONOTROU				
Référence	Code	Taille/Format		Prix public HT
D1674AA	C44572			70,40€

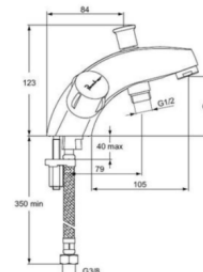

ULYSSE - MÉLANGEUR BAIN DOUCHE MURAL				
Référence	Code	Taille/Format		Prix public HT
D1648AA	C44573		SANS RACCORD	82,80€

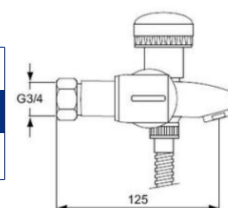

ULYSSE - MÉLANGEUR DOUCHE MURAL				
Référence	Code	Taille/Format		Prix public HT
D1652AA	C44577		SANS RACCORD	49,70€

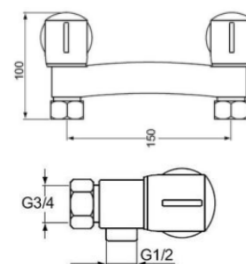

ULYSSE - MÉLANGEUR EVIER MONOTROU				
Référence	Code	Taille/Format		Prix public HT
D1689AA	C4457A		SUR GORGE	49,70€

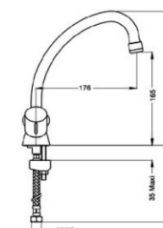

ULYSSE - ROBINET SIMPLE				
Référence	Code	Taille/Format		Prix public HT
D1625AA	C7674F			38,30€

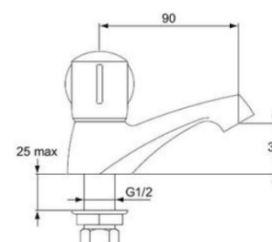

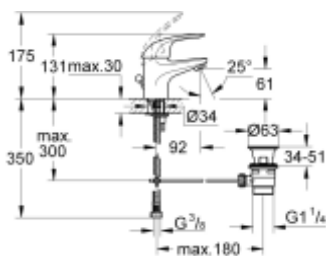

EUROECO - MITIGEUR LAVABO				
Référence	Code	Taille/Format	Prix public HT	
33262000	C00PIU	AVEC VIDAGE LAITON	52,00€	

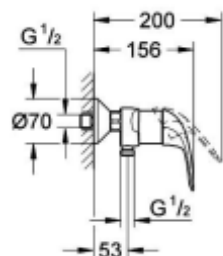
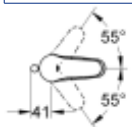

EUROECO - MITIGEUR DOUCHE MURAL				
Référence	Code	Taille/Format	Prix public HT	
32740000	C00PIV	AVEC RACCORDS	56,00€	

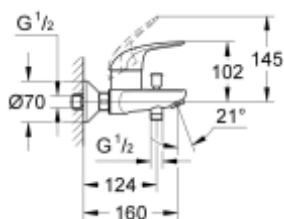
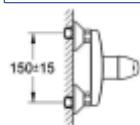

EUROECO - MITIGEUR BAIN DOUCHE MURAL				
Référence	Code	Taille/Format	Prix public HT	
32743000	C00PIW	AVEC RACCORDS	71,00€	

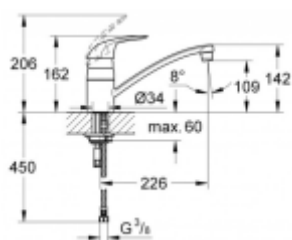
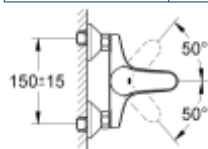

EUROECO - MITIGEUR BAIN EVIER				
Référence	Code	Taille/Format	Prix public HT	
32750000	C00PIX	SUR GORGE	60,00€	

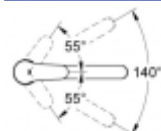

**GROHE - BAUEDGE PLUS**  
LE DESIGN ET LA QUALITÉ  
ACCESSIBLE A TOUS





EUROSMART - MITIGEUR LAVABO				
Référence	Code	Taille/Format		Prix public HT
32926001	C99527		AVEC VIDAGE LAITON	74,83€

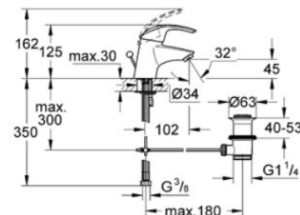

EUROSMART - MITIGEUR BIDET				
Référence	Code	Taille/Format		Prix public HT
32928001	C99528		AVEC VIDAGE	121,50€

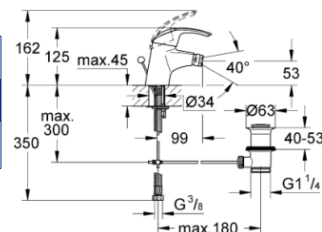

EUROSMART - MITIGEUR DOUCHE MURAL				
Référence	Code	Taille/Format		Prix public HT
32172001	C99802		AVEC RACCORDS	81,94€

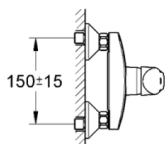
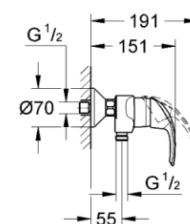

EUROSMART - MITIGEUR BAIN DOUCHE MURAL				
Référence	Code	Taille/Format		Prix public HT
32158001	C99452		AVEC RACCORDS	100,33€

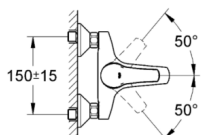
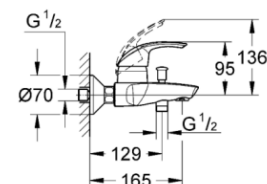

EUROSMART - MITIGEUR BAIN DOUCHE MONOTROU				
Référence	Code	Taille/Format		Prix public HT
33412001	C99458		SUR GORGE	131,00€

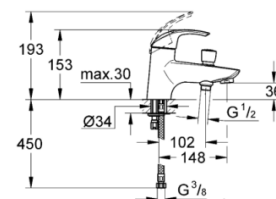

EUROSMART - MITIGEUR EVIER BEC HAUT MONOTROU				
Référence	Code	Taille/Format		Prix public HT
32223001	C0006L		SUR GORGE	135,50€

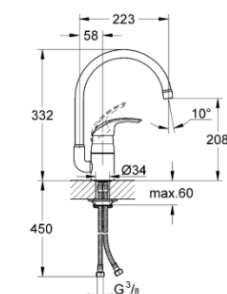

EUROSMART - MITIGEUR EVIER BEC BAS MONOTROU				
Référence	Code	Taille/Format		Prix public HT
32221001	C99696		SUR GORGE	114,55€

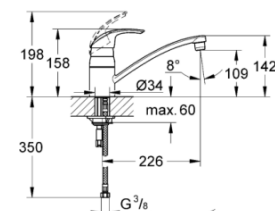

➔ **MITIGEURS EUROSMART COSMOPOLITAN**

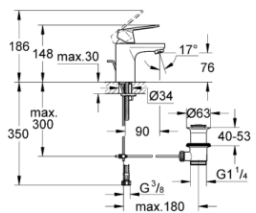

EUROSMART COSMOPOLITAN - MITIGEUR LAVABO				
Référence	Code	Taille/Format		Prix public HT
3282800	C00HEN		AVEC VIDAGE	104,00€

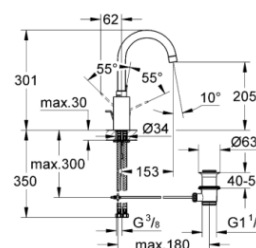

EUROSMART COSMOPOLITAN - MITIGEUR LAVABO				
Référence	Code	Taille/Format		Prix public HT
32830000	C00HJE		BEC HAUT AVEC VIDAGE	148,00€

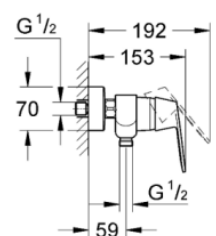

EUROSMART COSMOPOLITAN - MITIGEUR DOUCHE MURAL				
Référence	Code	Taille/Format		Prix public HT
32838000	C00HG0		AVEC RACCORD	114,50€

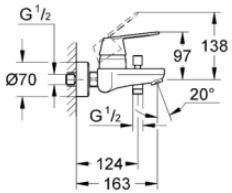
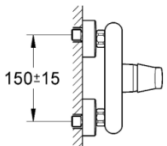

EUROSMART COSMOPOLITAN - MITIGEUR BAIN DOUCHE MURAL				
Référence	Code	Taille/Format		Prix public HT
32833000	C00HG1		AVEC RACCORD	137,50€

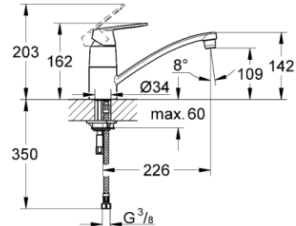
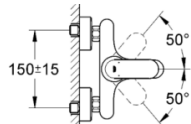

EUROSMART COSMOPOLITAN - MITIGEUR EVIER BEC BAS				
Référence	Code	Taille/Format		Prix public HT
32844000	C00HG2		SUR GORGE	150,00€

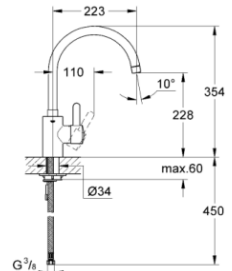

EUROSMART COSMOPOLITAN - MITIGEUR EVIER BEC HAUT				
Référence	Code	Taille/Format		Prix public HT
32845000	C9900T		SUR GORGE	150,00€





EUROSTYLE - MITIGEUR LAVABO				
Référence	Code	Taille/Format	Prix public HT	
33549001	C99801	AVEC VIDAGE LAITON	135,50€	

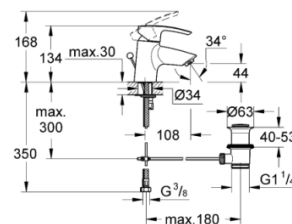

EUROSTYLE - MITIGEUR LAVABO BEC HAUT				
Référence	Code	Taille/Format	Prix public HT	
32444001	C99520	AVEC VIDAGE LAITON	155,50€	

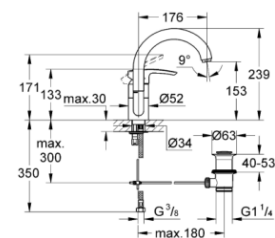

EUROSTYLE - MITIGEUR DOUCHE MURAL				
Référence	Code	Taille/Format	Prix public HT	
32229001	C99817	AVEC RACCORD	136,50€	

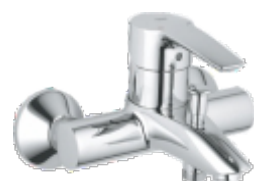
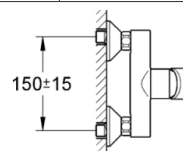
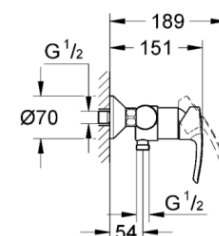

EUROSTYLE - MITIGEUR BAIN DOUCHE MURAL				
Référence	Code	Taille/Format	Prix public HT	
32228001	C99818	AVEC RACCORD	168,00€	

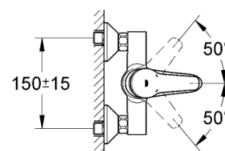
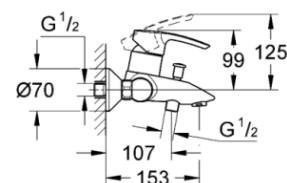

EUROSTYLE - MITIGEUR EVIER BEC HAUT				
Référence	Code	Taille/Format	Prix public HT	
32231001	C9996A	SUR GORGE	165,50€	

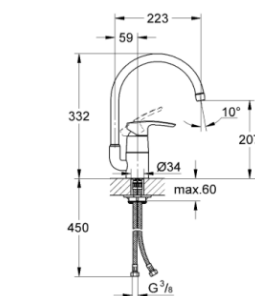

EUROSTYLE - MITIGEUR EVIER				
Référence	Code	Taille/Format	Prix public HT	
32230001	C0006J	SUR GORGE	165,50€	

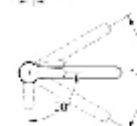
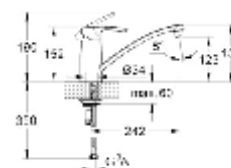

# → MITIGEURS EUROSTYLE COSMOPOLITAN

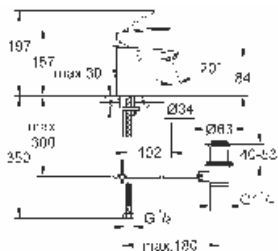

EUROSTYLE COSMOPOLITAN - MITIGEUR LAVABO				
Référence	Code	Taille/Format		Prix public HT
33549002	CA00TN		AVEC VIDAGE LAITON	132,11€

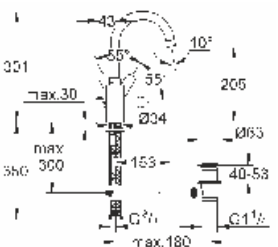

EUROSTYLE COSMOPOLITAN - MITIGEUR LAVABO BEC HAUT				
Référence	Code	Taille/Format		Prix public HT
23043002	CA003X		AVEC VIDAGE LAITON	154,68€

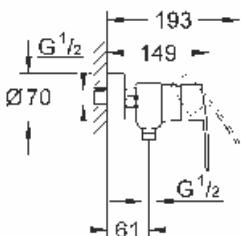

EUROSTYLE COSMOPOLITAN - MITIGEUR DOUCHE MURAL				
Référence	Code	Taille/Format		Prix public HT
32229002	CA0040			132,11€

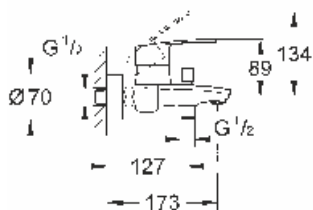

EUROSTYLE COSMOPOLITAN - MITIGEUR BAIN DOUCHE MURAL				
Référence	Code	Taille/Format		Prix public HT
32228002	CA0067			158,03

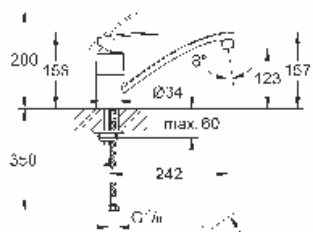

EUROSTYLE COSMOPOLITAN - MITIGEUR EVIER BEC BAS				
Référence	Code	Taille/Format		Prix public HT
32230002	C00M36			173,08€

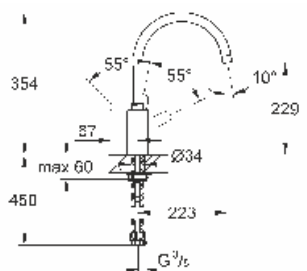

EUROSTYLE COSMOPOLITAN - MITIGEUR EVIER BEC HAUT				
Référence	Code	Taille/Format		Prix public HT
32231002	C00M37			173,08€







EURODISC COSMOPOLITAN - MITIGEUR EVIER BEC HAUT				
Référence	Code	Taille/Format	Prix public HT	
31122002	C9980A		SUR GORGE	235,00€

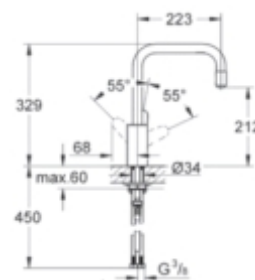

CONCETTO - MITIGEUR LAVABO				
Référence	Code	Taille/Format	Prix public HT	
32696001	CA03PP		AVEC VIDAGE LAITON	130,43€

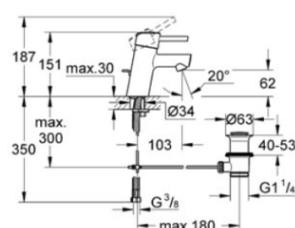

CONCETTO - MITIGEUR DOUCHE MURAL				
Référence	Code	Taille/Format	Prix public HT	
32699001	CA03PW		AVEC RACCORD	130,43€

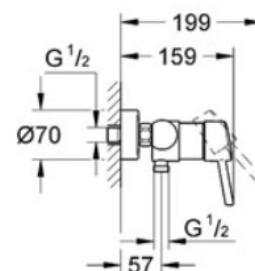
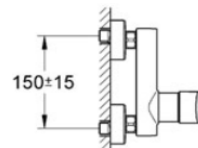

CONCETTO - MITIGEUR BAIN DOUCHE MURAL				
Référence	Code	Taille/Format	Prix public HT	
32700001	CA03PV		AVEC RACCORD	157,19€

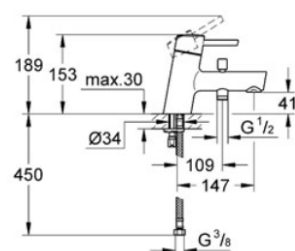

CONCETTO - MITIGEUR EVIER BEC BAS				
Référence	Code	Taille/Format	Prix public HT	
32660001	CA03PX		SUR GORGE	169,73€

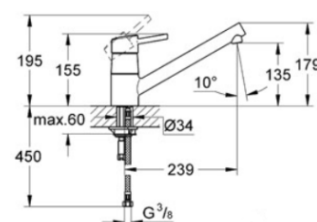

→ **MITIGEURS CONCETTO**

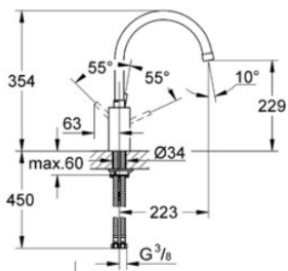

CONCETTO - MITIGEUR EVIER BEC HAUT				
Référence	Code	Taille/Format		Prix public HT
32662001	CA03PY		SUR GORGE	169,73€

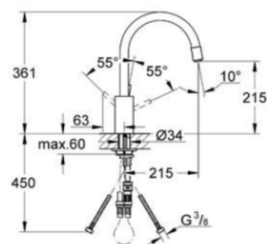

CONCETTO - MITIGEUR EVIER BEC HAUT				
Référence	Code	Taille/Format		Prix public HT
32663001	CA03Q0		AVEC MOUSSEUR EXTRACTIBLE	225,00€



→ **MITIGEURS ESSENCE**

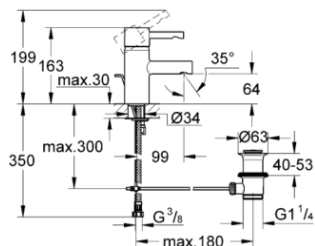

ESSENCE - MITIGEUR LAVABO				
Référence	Code	Taille/Format		Prix public HT
33562000	C9997A		AVEC VIDAGE LAITON	174,00€

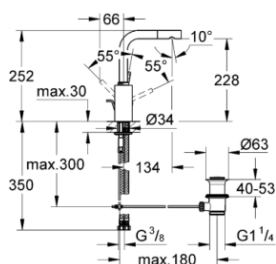

ESSENCE - MITIGEUR LAVABO BEC HAUT				
Référence	Code	Taille/Format		Prix public HT
32628000	CA03PB		AVEC VIDAGE LAITON	222,50€

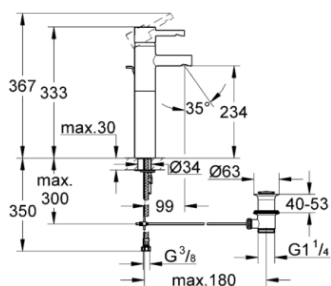

ESSENCE - MITIGEUR LAVABO REHAUSSE				
Référence	Code	Taille/Format		Prix public HT
32247000	C009F5		AVEC VIDAGE LAITON	285,50€





ESSENCE - MITIGEUR DOUCHE MURAL				
Référence	Code	Taille/Format		Prix public HT
33636000	C0063A		AVEC RACCORDS	203,50€

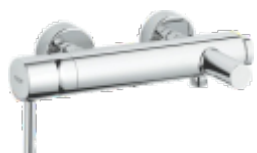
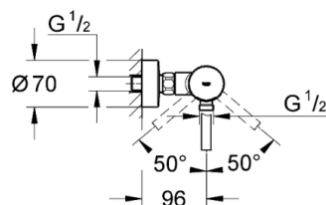
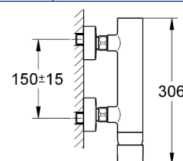

ESSENCE - MITIGEUR BAIN DOUCHE MURAL				
Référence	Code	Taille/Format		Prix public HT
33624000	C9997B		AVEC RACCORDS	253,00€

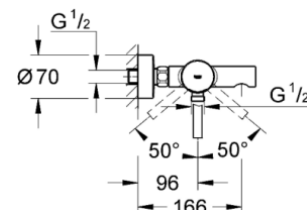
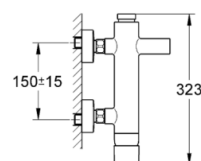

ESSENCE - MITIGEUR EVIER				
Référence	Code	Taille/Format		Prix public HT
32105000	C9961B		SUR GORGE	331,50€

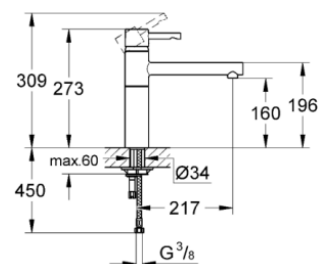

ESSENCE - MITIGEUR EVIER				
Référence	Code	Taille/Format		Prix public HT
32171000	C9986A		AVEC DOUCHETTE SUR GORGE	397,50€

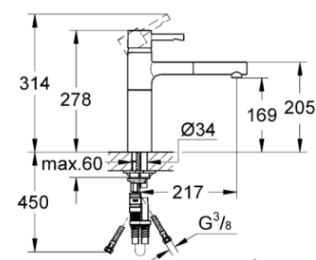

➔ **MITIGEURS BAUEDGE**

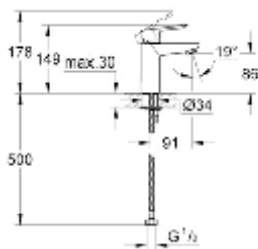

BAUEDGE - MITIGEUR LAVABO				
Référence	Code	Taille/Format		Prix public HT
23356000	C0005G		AVEC VIDAGE LAITON	104,52€

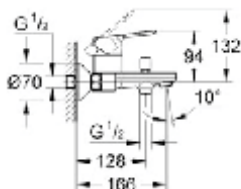
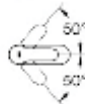

BAUEDGE - MITIGEUR BAIN DOUCHE				
Référence	Code	Taille/Format		Prix public HT
23334000	C0U483		AVEC RACCORD MURAL	129,60€

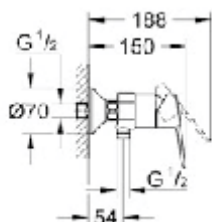
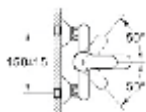

BAUEDGE - MITIGEUR DOUCHE				
Référence	Code	Taille/Format		Prix public HT
23333000	C0U484		AVEC RACCORD MURAL	114,55€

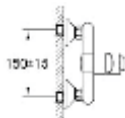

➔ **MITIGEURS EURODISC**

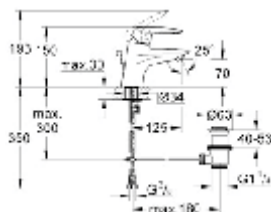

EURODISC - MITIGEUR LAVABO				
Référence	Code	Taille/Format		Prix public HT
33183001	C99632		AVEC VIDAGE LAITON	162,00€

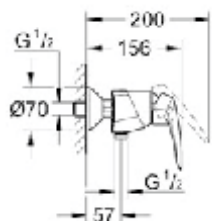
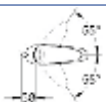

EURODISC - MITIGEUR DOUCHE MURAL				
Référence	Code	Taille/Format		Prix public HT
33569001	C99806		SANS RACCORDS	186,00€

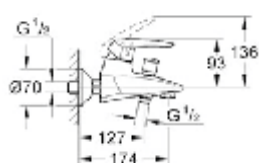

EURODISC - MITIGEUR BAIN DOUCHE				
Référence	Code	Taille/Format		Prix public HT
33390001	C99712		SANS RACCORDS	235,00€



# HANSAUNITA:

DESIGN MINIMALISTE, SECURITE MAXIMALE

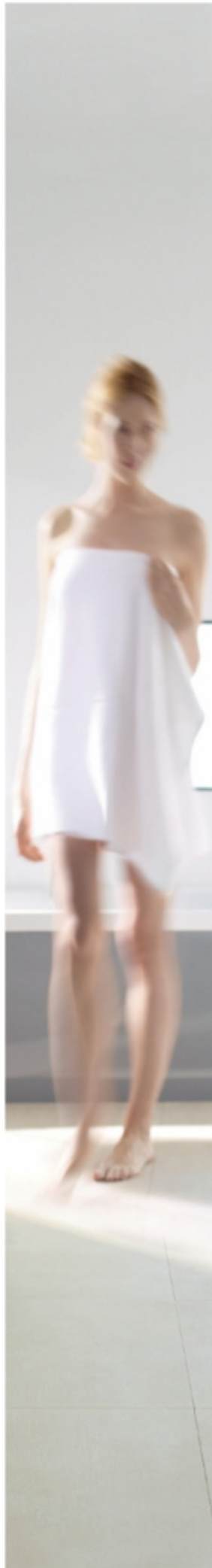

Mitigeur thermostatique  
5813 0101



Kit de Rénovation  
4813 0121  
**PPIHT : 240,00€**



Système de douche,  
tête carrée  
0999 9911



Système de douche  
5814 9103





PINTO - MITIGEUR LAVABO				
Référence	Code	Taille/Format		Prix public HT
45042203	C2584D		AVEC VIDAGE	111,00€

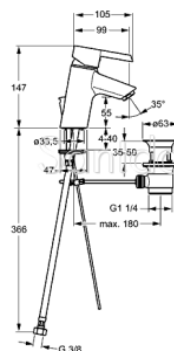

PINTO - MITIGEUR BAIN DOUCHE MURAL				
Référence	Code	Taille/Format		Prix public HT
45112103	C2584F		AVEC RACCORD	134,00€

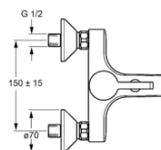
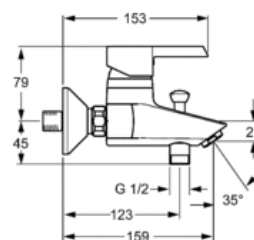

PINTO - MITIGEUR DOUCHE				
Référence	Code	Taille/Format		Prix public HT
45120103	C2584H		AVEC RACCORD	111,00€

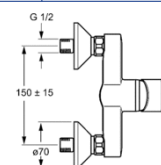
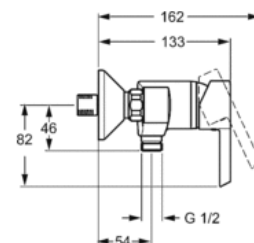

PINTO - MITIGEUR BAIN DOUCHE MONOTROU				
Référence	Code	Taille/Format		Prix public HT
45372203	C2584G		SUR GORGE	171,00€

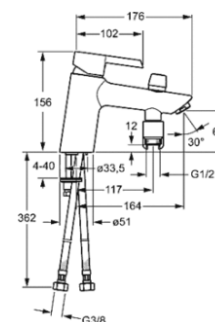

PINTO - MITIGEUR BAIN EVIER				
Référence	Code	Taille/Format		Prix public HT
45082203	C2584I		SUR GORGE	135,00€

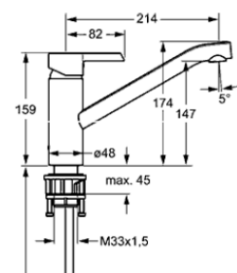



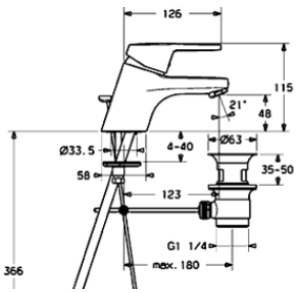

PRADO - MITIGEUR LAVABO				
Référence	Code	Taille/Format	Prix public HT	
01402273	C2389B		AVEC VIDAGE	136,00€

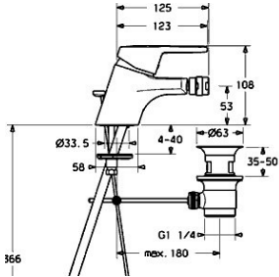

PRADO - MITIGEUR BIDET				
Référence	Code	Taille/Format	Prix public HT	
01433273	C2389C		AVEC VIDAGE	147,00€

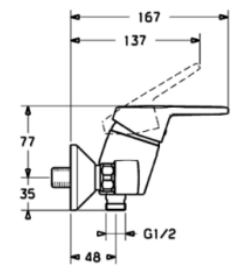

PRADO - MITIGEUR DOUCHE MURAL				
Référence	Code	Taille/Format	Prix public HT	
01450173	C2389E		AVEC RACCORD	147,00€

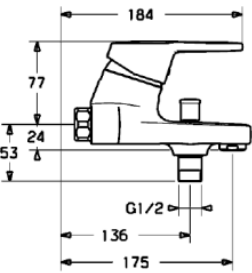
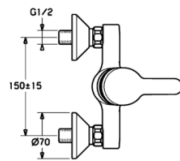

PRADO - MITIGEUR BAIN DOUCHE MURAL				
Référence	Code	Taille/Format	Prix public HT	
01442073	C2389D		SANS RACCORD	162,00€

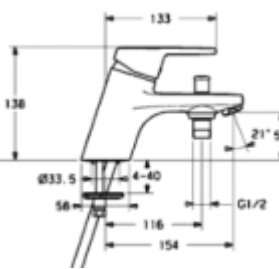
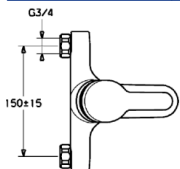

PRADO - MITIGEUR BAIN DOUCHE MONOTROU				
Référence	Code	Taille/Format	Prix public HT	
01512273	C2389F		SUR GORGE	198,00€

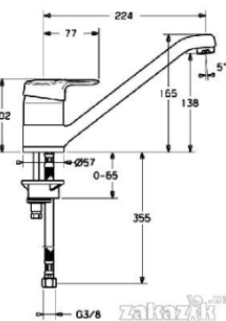

PRADO - MITIGEUR EVIER				
Référence	Code	Taille/Format	Prix public HT	
01482273	C2389G		SUR GORGE	192,00€





VANTIS STYLE - MITIGEUR LAVABO				
Référence	Code	Taille/Format		Prix public HT
52402277	C00P6W		AVEC VIDAGE	131,00€

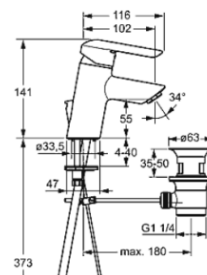

VANTIS STYLE - MITIGEUR LAVABO BEC HAUT				
Référence	Code	Taille/Format		Prix public HT
52542277	C2532D		AVEC VIDAGE	226,00€

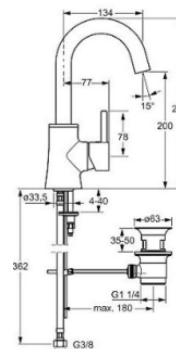

LUNA - MITIGEUR EVIER				
Référence	Code	Taille/Format		Prix public HT
10.211.033.000	C9589S		AVEC DOUCHETTE EXTRACTIBLE	321,00€

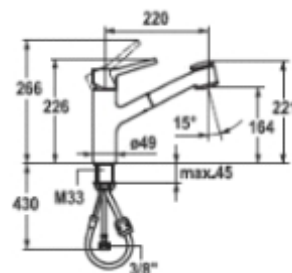

OLYOS - MITIGEUR LAVABO				
Référence	Code	Taille/Format		Prix public HT
D1107AA	C4455B		AVEC VIDAGE POLYPRO	47,96€

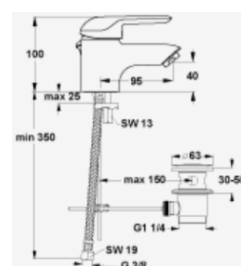

OLYOS - MITIGEUR DOUCHE				
Référence	Code	Taille/Format		Prix public HT
D1157AA	C000D8		AVEC RACCORDS MURAUX	50,71€

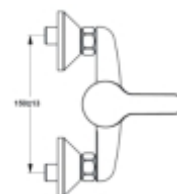

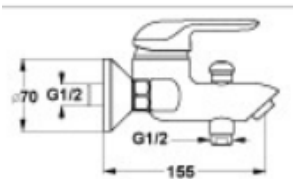

OLYOS - MITIGEUR BAIN DOUCHE MURAL				
Référence	Code	Taille/Format		Prix public HT
D1146AA	C44565		AVEC RACCORDS	68,21€

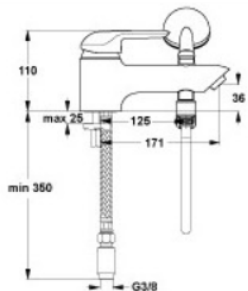
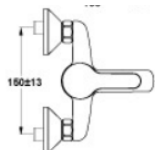

OLYOS - MITIGEUR BAIN DOUCHE MONOTROU				
Référence	Code	Taille/Format		Prix public HT
D1136AA	C4455G			98,10€

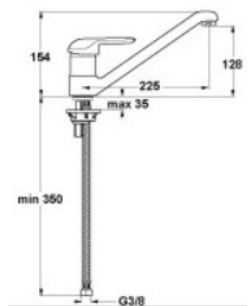

OLYOS - MITIGEUR EVIER BEC PROFILE				
Référence	Code	Taille/Format		Prix public HT
D1190AA	C00P1P		SUR GORGE	50,45€



→ **MITIGEURS CONNECT**

CONNECT - MITIGEUR LAVABO				
Référence	Code	Taille/Format		Prix public HT
B0175AA	C00R1G		AVEC VIDAGE LAITON	110,70€



CONNECT - MITIGEUR DOUCHE				
Référence	Code	Taille/Format		Prix public HT
B0181AA	C00R1J		AVEC RACCORDS	112,80€



CONNECT - MITIGEUR BAIN DOUCHE				
Référence	Code	Taille/Format		Prix public HT
B0179AA	C00R1H		AVEC RACCORDS	133,50€





CONNECT - MITIGEUR BAIN DOUCHE MONOTROU				
Référence	Code	Taille/Format		Prix public HT
B0180AA	C00R1I			136,60€



CONNECT - MITIGEUR BAIN DOUCHE MONOTROU				
Référence	Code	Taille/Format		Prix public HT
B0182AA	C00R1K		SUR GORGE	142,80€



CONNECT - MITIGEUR EVIER MONOTROU BEC TUBE				
Référence	Code	Taille/Format		Prix public HT
B0183AA	C00R1L			139,70€

**Infos +**
**Cartouche C3**

Cartouche répondant à la RT 2012 pour les bâtiments BBC.

Économie d'eau et économie d'énergie sur ECS (Eau Chaude Sanitaire).

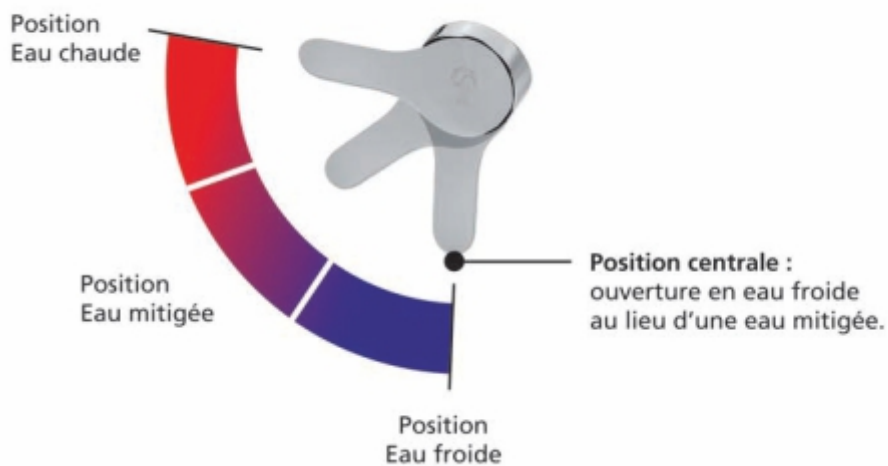



**Ideal**  
STANDARD

A  
BEAUTIFUL  
USE  
OF  
SPACE



Blanc brillant  
WG



Chêne clair  
SO

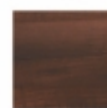

Noyer  
SX



Bois blanc  
KS



Gris Macadam  
KR

# Connect

Une collection, de multiples solutions

Que toute votre salle de bains ait besoin d'un coup de neuf ou que cette rénovation s'adresse à une zone en particulier, la collection Connect vous offre des solutions complètes ou des éléments à l'unité afin d'embellir votre espace. Mobilier, céramique, douche, baignoire, robinetterie, ne cherchez plus, tout est là !



NEW WAY - MITIGEUR EVIER MONOTROU			
Référence	Code	Taille/Format	Prix public HT
NY53051	C0006H		AVEC DOUCHETTE RETRACTABLE 180,54€

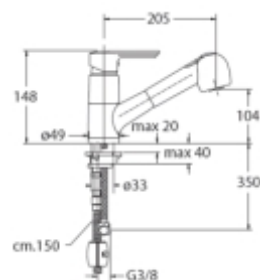



# NEW DAY

Pour la parfaite alliance du confort, de la technologie, et de l'esthétique



Cartouche  
céramique «life  
time Cristina »



Aérateur  
anticalcaire  
grille silicone

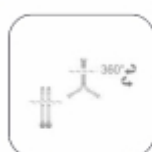

Flexibles inox  
anti-torsion

Des hauteurs et saillies de mitigeur de lavabo adaptées à toutes les configurations



Economie  
d'eau  
8l/min  
Economie  
d'énergie

#### Mitigeur lavabo **REGULAR**

- Hauteur 135 mm
- Saillie 100 mm
- Vidage laiton
- Option économie d'énergie



Economie  
d'eau  
8l/min  
Economie  
d'énergie

#### Mitigeur lavabo **LARGE**

- Hauteur 155 mm
- Saillie 110 mm
- Vidage laiton
- Option économie d'énergie



Economie  
d'eau  
8l/min

#### Mitigeur lavabo **XL**

- Hauteur 170 mm
- Saillie 114 mm
- Vidage laiton
- Economie d'eau 8l/min



Economie  
d'eau  
8l/min

#### Mitigeur lavabo **XXL**

- Hauteur 280 mm
- Saillie 140 mm
- Vidage up & down
- Economie d'eau 8l/min

Une gamme complète avec 16 modèles de robinetterie différents pour le lavabo, la douche et le bain



#### Colonne de douche **Thermostatique**

- Pomme sandwich ultra-plate  $\varnothing 25$  cm
- Thermostatique corps froid
- poignées métal
- Crosse orientable
- Flexible « long life »
- Tube recouplable



DESIGN

# Harmonie & Economies d'eau



So'o®

Robinet électronique  
avec réhausse

Presto Touch®

Robinet sensitif  
personnalisable



Une expertise marché reconnue

 **PRESTO**®  
We mean savings\*

[www.presto.fr](http://www.presto.fr) - [serviceclient@presto.fr](mailto:serviceclient@presto.fr)

\* Générateur d'économies

ROBINET LAVABO				
Référence	Code	Taille/Format		Prix public HT
63000	C80631		504 EF 1/2	42,12€
63100	C82047		P504S 1/2	52,27€



**FONCTIONNEMENT**

Le robinet sur plage pour lavabo permet l'écoulement d'eau par simple pression sur le bouton-poussoir. L'eau s'arrête automatiquement après une temporisation réglée en usine. Avec système S, il faut relâcher le bouton-poussoir pour que l'eau s'écoule.

**AVANTAGES**

- Débit pré-réglé à 3l/mn.
- Réglage du débit inaccessible aux usagers.
- Avec système S anti-blocage évitant le blocage en écoulement continu.
- Bouton non tournant avec pion de couleur indémontable.

ROBINET LAVABO				
Référence	Code	Taille/Format		Prix public HT
64602	C98289		605 EF 1/2	58,67€



**FONCTIONNEMENT**

Le robinet sur plage pour lavabo permet l'écoulement d'eau par simple pression sur le bouton-poussoir. L'eau s'arrête automatiquement après une temporisation réglée en usine.

**AVANTAGES**

- Débit pré-réglé à 3l/mn.
- Réglage du débit inaccessible aux usagers.
- Mécanisme breveté garantissant une temporisation constante.
- Bouton non tournant avec pion de couleur indémontable.

ROBINET LAVABO				
Référence	Code	Taille/Format		Prix public HT
68032	C1564A		3000 S	160,17€



**FONCTIONNEMENT**

Le robinet sur plage pour lavabo permet l'écoulement d'eau par simple pression sur le bouton-poussoir. L'eau s'arrête automatiquement après une temporisation réglée en usine. La sélection de la température se fait grâce à la manette latérale.

**AVANTAGES**

- Débit pré-réglé à 3l/mn.
- Réglage du débit inaccessible aux usagers.
- Mécanisme breveté garantissant une temporisation constante.
- Bouton non tournant avec pion de couleur indémontable.

ROBINET PRE-MÉLANGEUR				
Référence	Code	Taille/Format		Prix public HT
29403	C24277			71,05€



**FONCTIONNEMENT**

Le pré-mélangeur permet de distribuer de l'eau mitigée sur une robinetterie de lavabo ajustant grâce aux robinets de réglage intégrés la proportion d'eau chaude et d'eau froide.

**AVANTAGES**

- Entraxe ajustable grâce aux tubes cuivre
- Avec clapets anti-retour
- Robinets d'arrêts réglables avec tournevis plat.

ROBINET PILIER BEC TUBE				
Référence	Code	Taille/Format		Prix public HT
70702	C05111			49,03€



**AVANTAGES**

- Têtes DIN
- Garantie 10 ans
- Permet l'échange standard sans modification de l'installation.

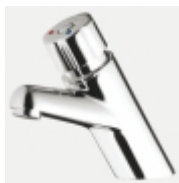

MITIGEUR MONOCOMMANDE LAVABO				
Référence	Code	Taille/Format		Prix public HT
28610	C15650		4000S BOUT LAITON	255,00€
28442	C24275		4000S BOUT NOIR	220,00€

**FONCTIONNEMENT**

Le mitigeur monocommande temporisé sur place pour lavabo permet l'écoulement d'eau par simple pression sur le bouton poussoir. L'eau s'arrête automatiquement après temporisation réglée en usine à 15 secondes. La rotation du bouton permet une sélection de température précise.

**AVANTAGES**

- Jusqu'à 70% d'économie d'eau grâce au réglage de débit
- Sécurité anti-brûlure par butée de température inviolable
- Dispositif breveté garantissant une temporisation constante
- Monocommande

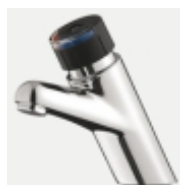

MITIGEUR MONOCOMMANDE LAVABO				
Référence	Code	Taille/Format		Prix public HT
30302	C24278		BEC FIXE SUR GORGE	55,00€

**FONCTIONNEMENT**

Le mitigeur monocommande temporisé sur place pour lavabo permet l'écoulement d'eau par simple pression sur le bouton poussoir. L'eau s'arrête automatiquement après temporisation réglée en usine à 15 secondes. La rotation du bouton permet une sélection de température précise.

**AVANTAGES**

- Sécurité anti-brûlure par butée de température inviolable
- Dispositif breveté garantissant une temporisation constante
- Bouton de commande permettant simultanément l'écoulement de l'eau et le réglage de la température.



COMMANDE FÉMORALE 712				
Référence	Code	Taille/Format		Prix public HT
3	C24281			81,20€

**FONCTIONNEMENT**

Le robinet pour lavabo permet l'écoulement d'eau par simple pression du genou sur la commande fémorale. L'eau s'arrête automatiquement dès que la pression n'est plus exercée sur la manette de commande fémorale.

**AVANTAGES**

- Hygiène : sans contact manuel
- Fixation murale
- Fermeture lente anti-coup de bélier
- Adapté pour lave-mains agroalimentaire



PRESTOSOL - 520				
Référence	Code	Taille/Format		Prix public HT
23600	C24272			99,47€

**FONCTIONNEMENT**

Le robinet au sol permet l'écoulement d'eau par simple pression du pied sur la pédale. L'eau s'arrête automatiquement après le retrait du pied.

**AVANTAGES**

- Hygiène : sans contact manuel
- Fixation murale ou au sol
- Pédale antidérapante avec butée de protection
- S'adapte à tous les becs.



DL 50 DOUCHE				
Référence	Code	Taille/Format		Prix public HT
38022	C24290			65,98€

**AVANTAGES**

- Réglage de débit inaccessible aux usagers
- Bouton non-tournant évitant tout risque d'usure prématurée
- Mécanisme garantissant une temporisation constante
- Fermeture lente anti-coup de bélier

APPLIQUE CHROMÉE DL400			
Référence	Code	Taille/Format	Prix public HT
27400	C2427C		162,40€

**AVANTAGES**

- Débit de 6l/mn
- Système anti-blocage S breveté évitant le blocage en écoulement continu
- Pomme de douche à picots anti-calcaire pour un confort optimum
- Avec robinet d'arrêt droit intégré.



POUSOIR POUR URINOIR - 12			
Référence	Code	Taille/Format	Prix public HT
31001	C24279		45,68€



ENSEMBLE POUR AUBAGNE			
Référence	Code	Taille/Format	Prix public HT
31993	C24284		66,99€

**AVANTAGES**

- Réglage de débit inaccessible aux usagers
- Bouton non-tournant évitant tout risque d'usure prématurée
- Mécanisme garantissant une temporisation constante
- Fermeture lente anti-coup de bélier



PRESTO ECLAIR - ROBINET WC			
Référence	Code	Taille/Format	Prix public HT
13001	C24271		72,07€

**FONCTIONNEMENT**

Le robinet pour chasse permet l'écoulement d'eau par simple pression sur le bouton-poussoir. Il délivre un volume d'eau constant.

**AVANTAGES**

- Volume d'eau délivré : 9 litres
- Conçu et testé pour un usage intensif
- Durabilité exceptionnelle
- Une chasse puissante





TEMPOSTOP - LAVABO MURAL				
Référence	Code	Taille/Format		Prix public HT
746000	C53063		1/2	44,29€
746001	C53066		1/2 AB	51,01€

Robinet temporisé mural de lavabo, avec sécurité Anti-Blocage en écoulement continu. Fermeture automatique temporisée à 15 sec. Débit pré-réglé à 3 litres/mn réglable par l'extérieur, sans démonter la cartouche, ni couper l'eau (Brevet DELABIE). Corps en laiton massif chromé. Brise-jet. Garantie 10 ans. Marque DELABIE type TEMPOSTOP AB Lavabo mural, Réf. 746001 (ou équivalent approuvé).

746001

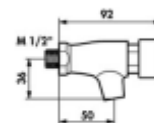

TEMPOSTOP - LAVABO 1/2				
Référence	Code	Taille/Format		Prix public HT
745100	C5192C			57,68€

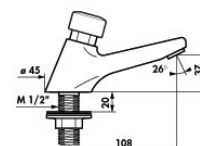

TEMPOMIX - MITIGEUR LAVABO MONO 1/2				
Référence	Code	Taille/Format		Prix public HT
795000	C54222			217,93€

Mitigeur temporisé de lavabo, à poser sur plage, avec réglage de température sur le volant-poussoir. Fermeture automatique temporisée 20 sec. et débit 3 litres/mn avec brise-jet à débit réglable. Limitation de température maximum et débit sont réglables par l'extérieur, sans démonter la cartouche, ni couper l'eau (Brevet DELABIE). Corps en laiton massif chromé. Livré avec fixation renforcée par 2 écrous, flexibles PEX, filtres et clapets anti-retour intégrés. Garantie 10 ans. Marque DELABIE type TEMPOMIX Lavabo Réf. 795000 (ou équivalent approuvé).

795000



TEMPOMATIC MIX 3 - MITIGEUR ELECTRONIQUE				
Référence	Code	Taille/Format		Prix public HT
492006	C2254E			435,06€

Mitigeur électronique de lavabo, à poser sur plage, avec module électronique à pile Lithium 6V et électrovanne intégrés dans le corps du mitigeur. Détection de présence infrarouge. Débit régulé à 3 litres/mn. avec brise-jet à débit réglable, et sécurité anti-blocage en écoulement. Réglage de température latéral. Rinçage périodique afin d'éviter les stagnations dans le réseau en cas de non utilisation prolongée. Corps en laiton massif chromé et fixation renforcée par 2 tiges inox et écrous, et capot de maintenance verrouillé par vis cachées. Livré avec flexibles PEX F3/8", robinets d'arrêt, clapets anti-retour et filtres. Marque DELABIE type TEMPOMATIC MIX 3 à pile intégrée. Réf. 492006 (ou équivalent approuvé).

492006

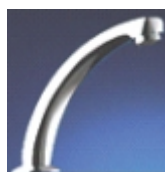
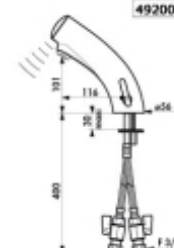

MITIGEUR LAVABO BEC FIXE				
Référence	Code	Taille/Format		Prix public HT
981142	C59965			63,35€

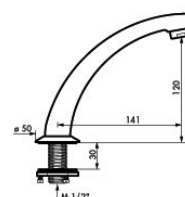

735400



TEMPOGENOU DROIT - COMMANDE FÉMORALE			
Référence	Code	Taille/Format	Prix public HT
735400	C5306A		82,34€

Robinet temporisé à commande au genou, par levier L.435 mm renforcé par tige inox intérieure. Fermeture automatique temporisée à 15 sec. et débit pré-réglé à 6 litres/mn. Rosace de fixation murale renforcée par 4 vis inox. Alimentation en eau froide ou eau mitigée. Garantie 10 ans. Marque DELABIE type Tempogenuou.



736101



MONO FOOT - ROBINET A PÉDALE			
Référence	Code	Taille/Format	Prix public HT
736001	C49598		114,41€

Robinet à commande au pied, à fermeture automatique instantanée. Débit réglé à 10 litres/mn. Alimentation en eau froide ou eau mitigée. Montage au sol ou mural. Garantie 10 ans. Marque DELABIE type Monofoot,



739100

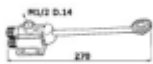

739102

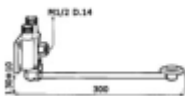

MIXFOOT - MITIGEUR A PÉDALE			
Référence	Code	Taille/Format	Prix public HT
739102	C5306B		134,15

Mitigeur à commande au pied, à fermeture automatique instantanée. Mélange pré-réglé ajustable et débit réglé à 15 litres/mn. Ouverture en eau froide puis en eau mitigée. Montage au sol ou mural. Pédale rabattable pour faciliter le nettoyage au sol. Garantie 10 ans. Marque DELABIE type Mixfoot, Réf.739100 (ou équivalent approuvé).



### PRE MÉLANGEUR MF 1/2

Référence	Code	Taille/Format	Prix public HT
D276043	C5306C		88,46€

Pré-mélangeur M 1/2" à poser sous lavabo pour distribution d'eau mitigée vers 1 robinet. Clapets anti-retour intégrés.

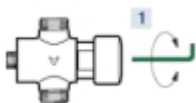

1 Réglage du débit sans démonter la cartouche, ni couper l'eau (Brevet DELABIE). Utiliser une clé Allen n° 3

TEMPOSTOP DOUCHE			
Référence	Code	Taille/Format	Prix public HT
749700	C5306D		69,66€

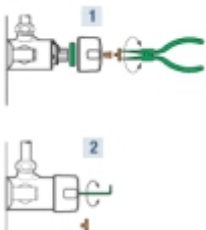
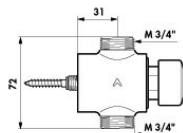

TEMPOMIX DOUCHE			
Référence	Code	Taille/Format	Prix public HT
790874	C5306E		203,46€







TEMPOMIX - KIT DOUCHE MURAL				
Référence	Code	Taille/Format		Prix public HT
790006	C59960			324,99€

Ensemble de douche pour pose murale en applique, avec mitigeur temporisé, colonne de liaison avec colliers, et pomme de douche inviolable en laiton massif chromé. Débit réglé à 6 litres/mn. avec diffuseur anti-tartre à jet orientable, et sécurité anti-brûlure. Alimentations M3/4" avec filtres et clapets anti-retour, livrées avec raccords robinets d'arrêt équerre M1/2" à écartement réglable. Garantie 10 ans. Marque DELABIE type TEMPOMIX Douche apparent.

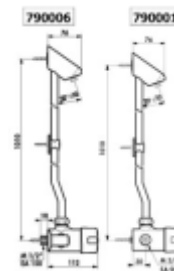

SPORTING - PANNEAU DOUCHE				
Référence	Code	Taille/Format		Prix public HT
714700	C57651			185,93€

Panneau de douche aluminium anodisé, à poser en applique, avec amorceur et pomme de douche inviolable en laiton massif chromé satiné. Débit réglé à 6 litres/mn. avec diffuseur anti-tartre à jet orientable. Alimentation M1/2" par le haut avec filtre et clapet anti-retour. Garantie 10 ans. Marque DELABIE type Panneau de douche SPORTING.

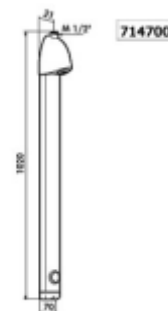

SPORTING - KIT DOUCHE MURAL A APPLIQUE				
Référence	Code	Taille/Format		Prix public HT
714000	C58815			196,50€



ACCESSOIRES URINOIRS				
Référence	Code	Taille/Format		Prix public HT
777000	C56497		TEMPOSTOP MM 1/2 DROIT	44,06€
751000	C54220		TUBULURE F 1/2	30,90€

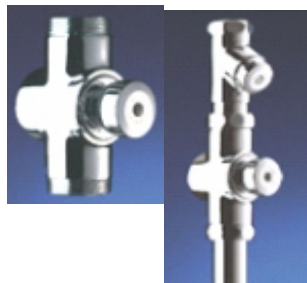

TEMPOCHASSE				
Référence	Code	Taille/Format		Prix public HT
760000	C53067		MM 1 1/4	78,44€
760004	C58818		APPARENT 1 1/4	185,26€

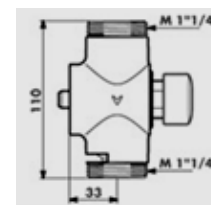

TEMPOMATIC - URINOIR				
Référence	Code	Taille/Format		Prix public HT
477006	C59961			705,29€

Robinetterie électronique pour rinçage automatique d'un urinoir individuel avec module électronique à pile Lithium 6V et électrovanne intégrés dans le corps du robinet. Détection de présence infrarouge. Sécurité anti-blocage en écoulement. Rinçage périodique toutes les 12h après la dernière utilisation. Capot de maintenance verrouillé par vis cachées. Marque DELABIE type TEMPOMATIC APPLIQUE URINOIR à pile Lithium

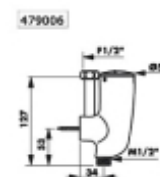



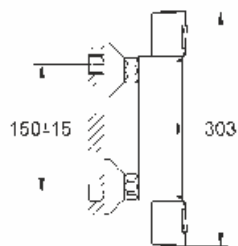

GROTHERM 1000 C3 - DOUCHE MURAL				
Référence	Code	Taille/Format		Prix public HT
34438000	CA0069		AVEC RACCORDS	199,83€

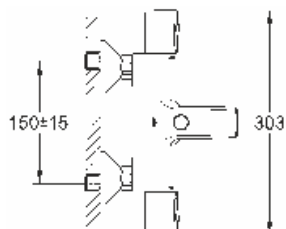
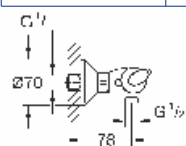

GROTHERM 1000 C3- BAIN DOUCHE MURAL				
Référence	Code	Taille/Format		Prix public HT
34439000	CA006A		SANS RACCORDS	267,56€

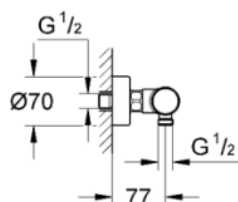
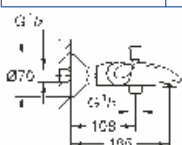

GROTHERM 1000 COSMOPOLITAN - DOUCHE MURAL				
Référence	Code	Taille/Format		Prix public HT
34065000	CA003R		AVEC RACCORDS	248,00€

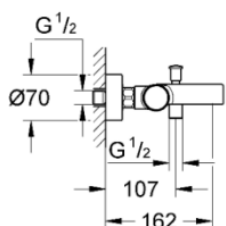
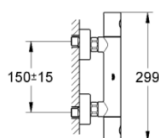

GROTHERM 1000 COSMOPOLITAN - BAIN DOUCHE				
Référence	Code	Taille/Format		Prix public HT
34215000	CA003V		AVEC RACCORDS	309,00€

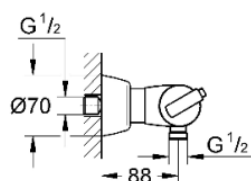
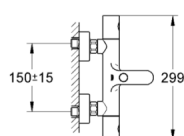

GROTHERM 2000 - DOUCHE MURAL				
Référence	Code	Taille/Format		Prix public HT
34169000	CA00DC		AVEC RACCORDS	338,00€

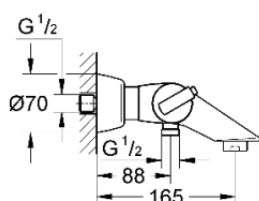
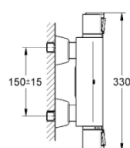

GROTHERM 2000 - BAIN DOUCHE MURAL				
Référence	Code	Taille/Format		Prix public HT
34174000	CA00D2		AVEC RACCORDS	396,50€

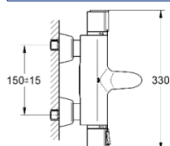

## → MITIGEURS THERMOSTATIQUES



GROTHERM 2000 - BAIN DOUCHE SUR GORGE				
Référence	Code	Taille/Format		Prix public HT
34176000	CA09K6		AVEC RACCORDS	492,00€

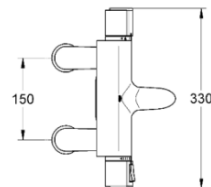
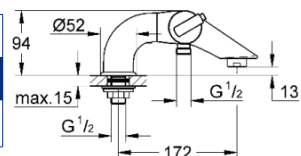

GROTHERM 2000 C3 - DOUCHE				
Référence	Code	Taille/Format		Prix public HT
34463001	C9897A		AVEC TABLETTE	329,00€

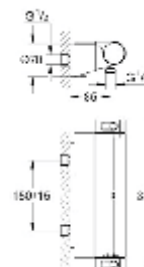

GROTHERM 2000 C3 - BAIN DOUCHE				
Référence	Code	Taille/Format		Prix public HT
34467001	C9897B		AVEC RACCORDS ET TABLETTE	419,00€

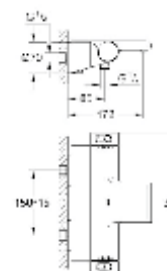

## → MITIGEURS THERMOSTATIQUES



UNITA - DOUCHE MURAL				
Référence	Code	Taille/Format		Prix public HT
58130101	C00MCU		AVEC RACCORDS	184,00€

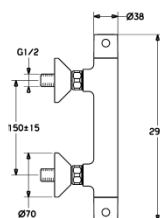
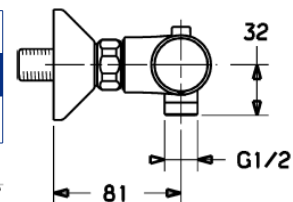

MICRA - DOUCHE				
Référence	Code	Taille/Format		Prix public HT
58150101	C80912		AVEC RACCORDS	228,00€

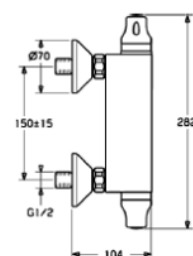

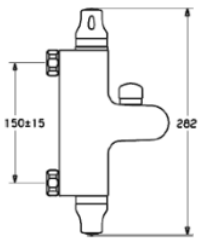

MICRA - BAIN DOUCHE				
Référence	Code	Taille/Format	Prix public HT	
58162001	C49959		SANS RACCORDS	265,00€

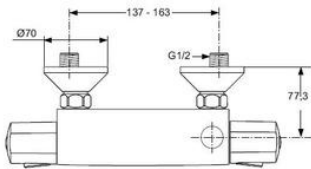
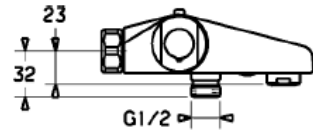

EASYTHERM - DOUCHE MURAL			
Référence	Code	Taille/Format	Prix public HT
D0436AA	C00P1R	AVEC RACCORDS	116,81€

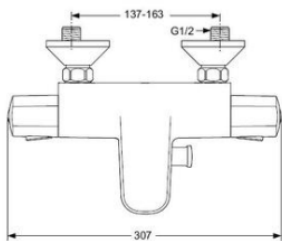
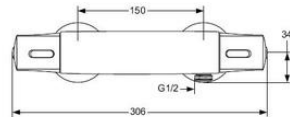

EASYTHERM - BAIN DOUCHE MURAL			
Référence	Code	Taille/Format	Prix public HT
D0443AA	C00P1Q	AVEC RACCORDS	173,55 €

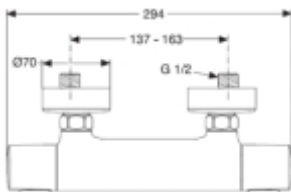
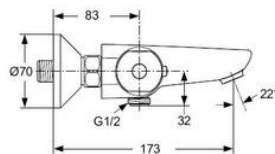

CERATHERM - DOUCHE			
Référence	Code	Taille/Format	Prix public HT
A4618AA	C00P2K	AVEC RACCORDS	194,10€

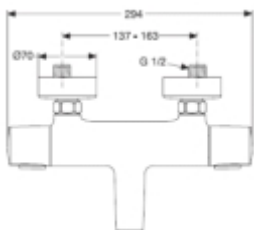
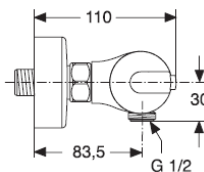

CERATHERM - BAIN DOUCHE MURAL			
Référence	Code	Taille/Format	Prix public HT
A4623AA	C00P2J	AVEC RACCORDS	253,80€

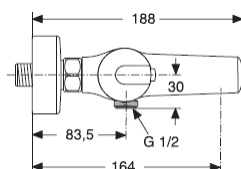



UNITA - ENSEMBLE DOUCHE THERMOSTATIQUE RENOVATION			
Référence	Code	Taille/Format	Prix public HT
48130121	C00M6D		MITIGEUR + BARRE DE DOUCHE 252,00€

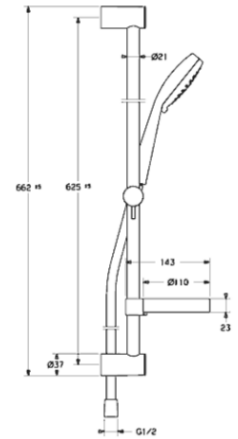
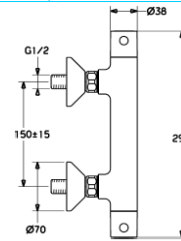

THETA CONFORT - ENSEMBLE DOUCHE THERMOSTATIQUE			
Référence	Code	Taille/Format	Prix public HT
TE45651	C00EZ6		MITIGEUR + COLONNE 442,31€

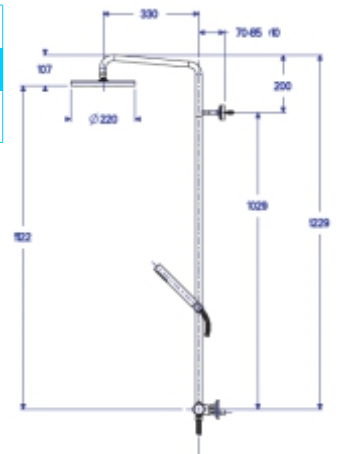
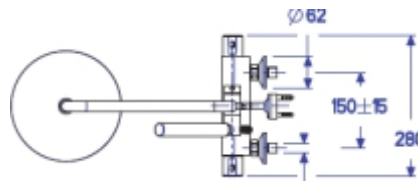

THETA QUADRI - ENSEMBLE DOUCHE THERMOSTATIQUE			
Référence	Code	Taille/Format	Prix public HT
QD48651	C00EZ7		MITIGEUR + COLONNE 826,92€

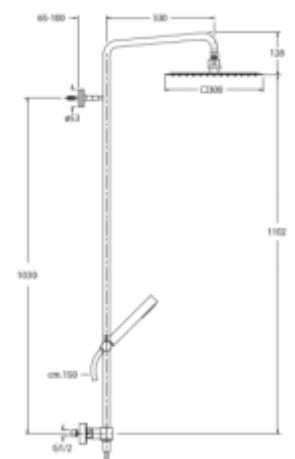
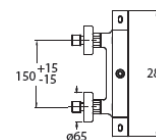

→ **ENSEMBLES THERMOSTATIQUES**

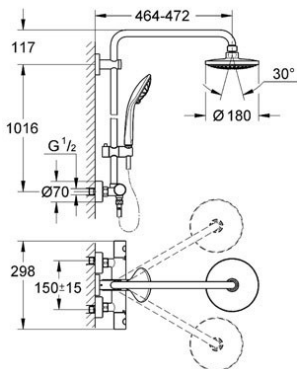

EUPHORIA SYSTEM - ENSEMBLE DOUCHE THERMOSTATIQUE				
Référence	Code	Taille/Format		Prix public HT
27296001	C0059B		MITIGEUR + COLONNE	693,50€



**hansgrohe**

→ **ENSEMBLES THERMOSTATIQUES**

SHOWERPIPE CROMA 220 - ENSEMBLE DOUCHE THERMOSTATIQUE				
Référence	Code	Taille/Format		Prix public HT
27185000	C6913B		MITIGEUR + COLONNE	595,00€



SHOWERPIPE SELECT 240 - ENSEMBLE DOUCHE THERMOSTATIQUE				
Référence	Code	Taille/Format		Prix public HT
27115000	C24318		MITIGEUR + COLONNE	775,00€



COMBI CROMA 100 VARIO ECOSTAT - ENSEMBLE DOUCHE THERMOSTATIQUE				
Référence	Code	Taille/Format		Prix public HT
27034000	C7912H		MITIGEUR + COLONNE	284,00€

- Mitigeur thermostatique Ecostat 1001 SL
- Barre de douche Unica 'C 0,65 m
  - Curseur inclinable réglable en hauteur
  - Flexible Isiflex 1,60 m
  - Douchette Croma 100 Multi
  - Porte-savon Cassetta 'C chromé





CORAL



CORAL

**TEMPESTA 2 - ENSEMBLE DOUCHE COMPLET**

Référence	Code	Taille/Format	Prix public HT
27598000	CA008S		56,02€

**Nouvelle Tempesta Set de douche 2 jets**

- Douchette II (27 597 000)
- Barre de douche 600 mm (27 523)
- Flexible Relaxaflex 1750 mm (28 154)
- GROHE DreamSpray® jet parfaitement uniforme
- GROHE CoolTouch® Minimise les risques de brûlures
- GROHE StarLight® chrome éclatant et durable
- Procédé anti-calcaire SpeedClean®
- Inner WaterGuide longévité maximale
- ShockProof anneau en silicone

**TEMPESTA 3 - ENSEMBLE DOUCHE COMPLET**

Référence	Code	Taille/Format	Prix public HT
27794000	CA008W		76,00€

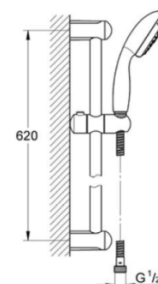
**TEMPESTA 4 - ENSEMBLE DOUCHE COMPLET**

Référence	Code	Taille/Format	Prix public HT
28593001	C00KYX	AVEC PORTE SAVON	97,50€

**Nouvelle Tempesta Set de douche 4 jets**

- GROHE StarLight® chrome éclatant et durable
- GROHE CoolTouch® Minimise les risques de brûlures
- GROHE DreamSpray® jet parfaitement uniforme
- GROHE EasyReach® porte savon (27 596)
- Constitué de:
- Douchette 4 jets (28 578 001)
- Barre de douche 600 mm (27 523)
- Flexible Relaxaflex 1750 mm (28 154)
- Procédé anti-calcaire SpeedClean®
- Inner WaterGuide longévité maximale
- ShockProof anneau en silicone

**EUPHORIA - ENSEMBLE DOUCHE COMPLET**

Référence	Code	Taille/Format	Prix public HT
2723001	CA008X	AVEC PORTE SAVON	86,12€

**TEMPESTA 2 - DOUCHETTE**

Référence	Code	Taille/Format	Prix public HT
27597000	CA008Y		25,00€



TEMPESTA 3 - DOUCHETTE			
Référence	Code	Taille/Format	Prix public HT
28261001	CA008Z		34,70€

**Nouvelle Tempesta Douchette 3 jets**

- 3 jets : GROHE Rain O2, Rain Massage  
Ø 100 mm
- Procédé anti-calcaire SpeedClean®
- Inner WaterGuide longévité maximale
- ShockProof anneau en silicone
- Système de montage universel: s'associe avec tous les flexibles de douche



TEMPESTA 4 - DOUCHETTE			
Référence	Code	Taille/Format	Prix public HT
28578001	C00KYZ		45,60€

**hansgrohe**

SET CHROMA 100 VARIO - ENSEMBLE DOUCHE			
Référence	Code	Taille/Format	Prix public HT
27594000	C6912B	AVEC SUPPORT MURAL	60,00€

Douchette Croma 100 Vario

- Débit : 12 à 18 l/min sous 3 bars de pression
- Support de douche Porter 'S
- Flexible Isiflex 1,60 m



SET CROMETTA 85 VARIO - ENSEMBLE DOUCHE			
Référence	Code	Taille/Format	Prix public HT
27559000	C0061W	AVEC SUPPORT MURAL	33,03€

Douchette Crometta 85 Vario

- Débit : 12 à 14 l/min sous 3 bars de pression
- Support de douche Porter 'C
- Flexible Isiflex 1,60 m

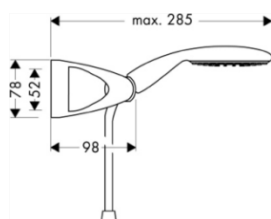

SET RAINDANCE E100 - ENSEMBLE DOUCHE			
Référence	Code	Taille/Format	Prix public HT
27573000	C0016Y	AVEC SUPPORT MURAL	104,10€

Douchette à main Raindance E 100 AIR 1 jet

- Débit : 18 l/min sous 3 bars de pression
- Support mural Porter 'D inclinable
- Flexible Isiflex 1,60 m





SET CROMETTA 85 VARIO - ENSEMBLE BARRE DE DOUCHE			
Référence	Code	Taille/Format	Prix public HT
27764000	C7485H		52,68€

comprenant :

- Douchette Crometta 85 Vario
- Débit : 12 à 14 l/min sous 3 bars de pression
- Barre de douche Unica' Crometta 0,65 m
- Curseur à 2 positions chromé
- Flexible Metaflex 1,60 m
- Porte-savon Casetta'S transparent
- Cale de compensation 7 mm



SET CHROMA 100 VARIO - ENSEMBLE BARRE DE DOUCHE			
Référence	Code	Taille/Format	Prix public HT
27772000	C6912C		75,25€

comprenant:

- Douchette Croma 100 Vario
- Débit : 12 à 18 l/min sous 3 bars de pression
- Barre de douche Unica'C 65 cm, Ø 22 mm
- Curseur inclinable réglable en hauteur
- Flexible Isiflex 1,60m
- Porte-savon Casetta'C chromé
- Cale de compensation 7 mm



SET CHROMA 100 MULTI ECOSMART - ENSEMBLE BARRE DE DOUCHE			
Référence	Code	Taille/Format	Prix public HT
27777000	C6912H		113,10€

comprenant:

- Douchette Croma 100 Multi EcoSmart à économie d'eau
- Débit : 9 l/min sous 3 bars de pression
- Barre de douche Unica'C 0,65 m
- Ø 22 mm
- Curseur inclinable réglable en hauteur
- Flexible Isiflex 1,60m
- Porte-savon Casetta'C chromé



SET RAINDANCE SELECT E 120 - ENSEMBLE BARRE DE DOUCHE			
Référence	Code	Taille/Format	Prix public HT
26620000	C7912I		169,00€

comprenant :

- Douchette Raindance Select E 120 3jet EcoSmart
- Débit 9l/min sous 3 bars de pression
- Barre de douche Unica'S Puro 0,65 m
- Flexible Isiflex 1,60 m
- Porte-savon Casetta E
- Cale de compensation 7 mm



SET AUBADE CRÉATION - ENSEMBLE BARRE DE DOUCHE			
Référence	Code	Taille/Format	Prix public HT
27771000	CA0D5W		83,19€

comprenant:

- Douchette Croma 100 Vario
- Barre de douche Unica'C 90 cm,
- Ø 22 mm
- Flexible Isiflex 1,60m
- Porte-savon Casetta'C chromé

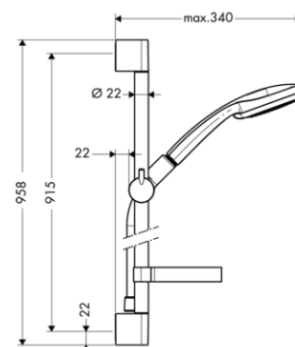

FLEXIBLES DE DOUCHE				
Référence	Code	Taille/Format		Prix public HT
28266000	C6913A		METAFLEX C 1,60 ML	11,50€
28276000	C69139		ISIFLEX B 1,60 ML	25,10€

- Flexible synthétique très souple métallisé et sous forme de spirale.
- Adapté à l'eau potable conformément à la norme DVGW



CROMETTA 100 VARIO - DOUCHETTE SEULE				
Référence	Code	Taille/Format		Prix public HT
28562000	C7485I			24,30€

La douchette 2 jets Crometta 85 Vario est un classique de la marque Hansgrohé. Cette douchette est reconnue.



CHROMA 100 VARIO - DOUCHETTE SEULE				
Référence	Code	Taille/Format		Prix public HT
28535000	C7458A			34,70€

Avec ses 4 jets à intensité variable, la douchette Chroma100 Vario renouvelle le plaisir de la douche.



CHROMA 100 MULTI - DOUCHETTE SEULE				
Référence	Code	Taille/Format		Prix public HT
28536000	C7458B			62,40€

- 3 types de jets :
- Jet pluie, massage et mono
  - Système anti-calcaire QuickClean



RAINDANCE SELECT 120 - DOUCHETTE SEULE				
Référence	Code	Taille/Format		Prix public HT
26520000	C6913D			84,00€

- Technologie AirPower
- Système anti-calcaire QuickClean
- Changement de jet par bouton Select, plus confortable
- 3 types de jet : RainAir, Rain, Whirl Filtre
- Convient au chauffe-eau instantané



# ESPACE Aubade

SANITAIRE • CARRELAGE • CHAUFFAGE



Tendances 2013

SUPER COBRA 3 - ENSEMBLE BARRE			
Référence	Code	Taille/Format	Prix public HT
791100000	C80405		67,01€

Ensemble de douche Supercobra, douchette

- 3 jets : pluie, massant, moussant Néoperl®
- système anti-calcaire à picôts souples
- changement des jets par rotation de la tête de la douchette
- embout tournant (évite au flexible de se tordre)
- joint réducteur de débit
- barre de douche Totema ø25 avec porte-savon
- entraxe de perçage : 604 mm
- flexible universel PVC renforcé Valflex 1,75 m anti-pincement



MUTINE 2 - ENSEMBLE BARRE			
Référence	Code	Taille/Format	Prix public HT
975200004	C80406		27,30€

Ensemble de douche MUTINE 2 jets pluie, massant

- système anti-calcaire à picôts souples
- changement des jets par rotation de la tête de la douchette
- barre de douche Modulo ø18 avec porte-savon
- entraxe variable (permet d'éviter un perçage au montage)
- flexible universel métal 1,50 m



GO STOP - ENSEMBLE BARRE			
Référence	Code	Taille/Format	Prix public HT
878600000	C6114B		44,07€

Ensemble de douche GO STOP 2 jets

- système anti-calcaire à picôts souples
- changement des jets par rotation de la tête de la douchette
- fonction stop
- barre de douche Modulo ø25 avec tablette
- entraxe variable
- tube longueur 650 mm
- flexible universel double agrafage 1,50 m





GO STOP - ENSEMBLE DOUCHE			
Référence	Code	Taille/Format	Prix public HT
914300000	C8040F		26,58€

KIT de douche GO STOP 2 jets

- système anti-calcaire à picôts souples
- changement des jets par rotation de la tête de la douchette
- fonction stop
- support mural 3 positions
- flexible universel double agrafage 1,50 m



SUPER NARVANNE - ENSEMBLE DOUCHE			
Référence	Code	Taille/Format	Prix public HT
930200100	C05626		12,25€

SUPER NARVANNE - Garniture de douche comprenant :

- Douchette 1 jet
- Flexible nylon tressé de 1,50 m
- Support rotule
- Finition blanc



COBRA 1 - ENSEMBLE DOUCHE			
Référence	Code	Taille/Format	Prix public HT
910500000	C80413		18,45€

COBRA - Garniture de douche comprenant :

- Douchette 1 jet
- Flexible valflex de 1,50 m
- Support rotule ABS
- Finition chromée



SUPER COBRA 3 - DOUCHETTE SEULE			
Référence	Code	Taille/Format	Prix public HT
952600000	C05601		23,60€

Douchette SUPERCobra

- 3 jets : pluie, massant, moussant Néoperl
- Système anti-calcaire à picôts souples
- Changement de jets par rotation de la tête de la douchette
- Embout tournant
- Joint réducteur de débit



DOUCHETTES SEULES				
Référence	Code	Taille/Format		Prix public HT
953200000	C05605		PULCINA	20,21€
518000000	C05606		MUTINE 2	10,33€
906300000	C05607		COBRA 1	5,48€
920700100	C05608	SUPER NARVANNE BLANCHE - DOUCHETTE JET DE PLUIE		2,54€



GO STOP - DOUCHETTE SEULE				
Référence	Code	Taille/Format		Prix public HT
908400000	C8040E			17,71€



Douchette GO STOP 2 jets  
 - système anti-calcaire à picôts souples  
 - changement des jets par rotation de la tête de la douchette  
 - fonction stop

ENSEMBLE SUPPORT HAUT CHROME				
Référence	Code	Taille/Format		Prix public HT
988200000	C05616			9,14€



SUPPORTS				
Référence	Code	Taille/Format		Prix public HT
996000000	C05619	SUPPORT SUR ROBINETTERIE		5,52€
997200000	C05620	SUPPORT 3 POSITIONS		6,83€
903500000	C80409	SUPPORT DESSUS/DESSOUS		5,52€
071500000	C22747	CURSEUR POUR TOTEMA		12,34€



DIVERS ACCESSOIRES				
Référence	Code	Taille/Format		Prix public HT
985000000	C05641	COLONNE EQUERRE CHROMÉE 1,10 ML		24,40€
985200000	C05643	POMME GALERIE 80 CHROME		9,20€



FLEXIBLES CHROMES				
Référence	Code	Taille/Format		Prix public HT
990200000	C05650	SA 150 EC 1/2 - 1/2		7,20€
990300000	C05652	SA 200 EC 1/2 - 1/2		11,07€
988800000	C05654	DA 150 EC 1/2 - 1/2		11,29€
988900000	C05656	DA 200 EC 1/2 - 1/2		14,83€



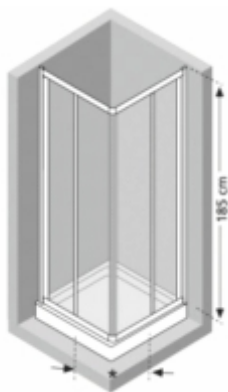

RIVIERA - PAROIS ACCÈS ANGLE				
Référence	Code	Taille/Format		Prix public HT
RIVIA70-6A	C46931		A70 BLANC VERRE TREMPE	231,80€
RIVIA80-6A	C46626		A80 BLANC VERRE TREMPE	256,50€

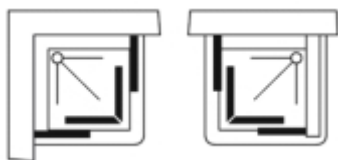

COD. 6

granité



COD. A

blanc



RIVIERA - PAROIS BLANCHES VERRE TREMPE				
Référence	Code	Taille/Format		Prix public HT
RIVIG80-6A	C46936		PORTE PIVOTANTE G80	186,20€
RIVIG90-6A	C2566A		PORTE PIVOTANTE G90	201,40€
RIVIFC80-6A	C44909		PANNEAU FIXE F80	146,30€
RIVIFC90-6A	C44646		PANNEAU FIXE F90	155,80€



TOP LINE - PORTES PIVOTANTES CHROME BRILLANT 07					
Référence	Code	Largeur	Hauteur		Prix public HT
AUPP08005007	C9818T	800	1900		311,04€
AUPP09005007	C9818U	900	1900		318,56€
AUPP10005007	C9818V	1000	1900		335,28€

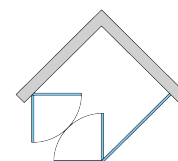
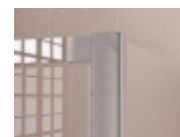

TOP LINE - PORTES COULISSANTE 3 VOILETS BLANC 07					
Référence	Code	Largeur	hauteur		Prix public HT
AUOS309000407	C0055J	800	1900		335,28€
AUOS310000407	C00HT9	1000	1900		358,70€
AUOS312000407	C00HTC	1200	1900		392,28€

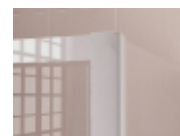

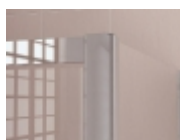

TOP LINE - PAROIS FIXES CHROME BRILLANT 07					
Référence	Code	Largeur	Hauteur		Prix public HT
AUPF08005007	C9818W	800	1900		165,55€
AUPF09005007	C9818X	900	1900		178,93€
AUPF10005007	C9818Y	1000	1900		190,64€

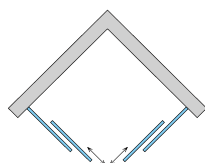

TOP LINE - ACCÈS ANGLE COULISSANT CHROME BRILLANT 07					
Référence	Code	Largeur	Hauteur		Prix public HT
AUPAC08005007	C9818M	800	1900		424,75€
AUPAC09005007	C9818N	900	1900		449,83€
AUPAC10005007	C9818P	1000	1900		470,74€



TOP LINE - 1/4 DE ROND R55 CHROME BRILLANT 07					
Référence	Code	Largeur	Hauteur		Prix public HT
AUPR550905007	C9818R	900	1900		627,09€
AUPR551005007	C9818S	1000	1900		640,47€

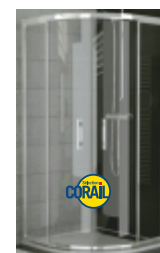

TOP LINE - COULISSANT 2 VOILETS CHROME BRILLANT 07					
Référence	Code	Largeur	Hauteur		Prix public HT
AUPS212005007	C9818B	1200	1900		403,85€

TOP LINE - KIT BÉQUILLE PLAFOND OU BARRE STABILISATION					
Référence	Code	Taille/Format			Prix public HT
AUBTB501900	C9819G				87,79€
AUBTB041900	C00HDI				87,79€

TOP LINE - PROFILE D'ELARGISSEMENT PORTES OU PAROIS					
Référence	Code	Taille/Format			Prix public HT
ACT1501900	C00H3S	25			40,13€
ACT1041900	C00HDG	25			38,46€
ACT2501900	C002K9	40			40,13€
ACT2041900	C00HDH	40			38,46€



ELYS - PORTE PIVOTANTE POLI BRILLANT 07					
Référence	Code	Largeur	Hauteur		Prix public HT
ACSL108005007	C00HDM	800	1950		553,52€
ACSL109005007	C002MM	900	1950		571,07€
ACSL110005007	C002ME	1000	1950		593,05€



ELYS - PAROI FIXE 90° POLI BRILLANT 07					
Référence	Code	Largeur	Hauteur		Prix public HT
ACSLT10805007	C002MW	800	1950		379,60€
ACSLT10905007	C002MZ	900	1950		397,16€
ACSLT11005007	C002N0	1000	1950		415,55€



ELYS - PORTE BATTANTE 1/4 ROND POLI BRILLANT 07					
Référence	Code	Rayon	Hauteur		Prix public HT
ACSR550805007	C002N2	550	1950		1.002,51€
ACSR550905007	C002N3	551	1950		1.034,28€
ACSR551005007	C002N4	552	1950		1.065,22€



VOILIER - PAROIS FIXES VERRE TRANSPARENT					
Référence	Code	Largeur	Hauteur		Prix public HT
PDT4AC0901007	C00PAE	900	2000		613,71€
PDT4AC1001007	C00PAF	1000	2000		636,29€
PDT4AC1201007	C00PAG	1200	2000		683,95€



CORAIL CARRE - CABINE COMPLÈTE AVEC PORTE PIVOTANTE			
Référence	Code	Taille/Format	Prix public HT
L11CL3088	C81965	80 x 80	639,00€
CONTENANT : • 1 MITIGEUR THERMOSTATIQUE • 3 COTES • 1 PORTE PIVOTANTE			



→ PRENDRE LES MESURES

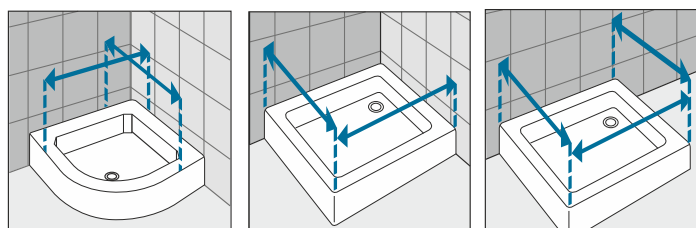

Prendre les mesures du mur au bord extérieur du receveur de douche. Relever les mesures après la pose du carrelage.

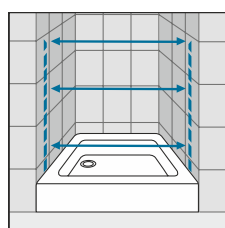

Prendre les mesures d'un mur à l'autre, en bas, en haut et au milieu et choisir la mesure inférieure. Relever les mesures après la pose du carrelage.

→ RECONNAÎTRE LES LOGOS



Produits exclusifs Espace Aubade

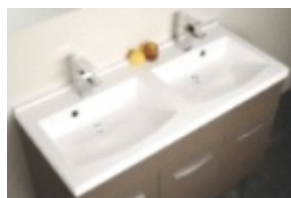
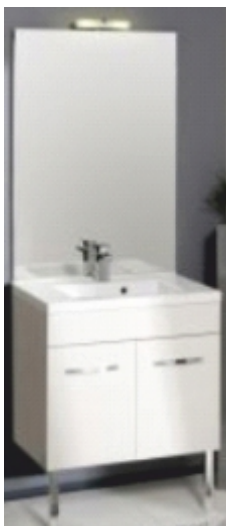

Le meilleur rapport qualité/prix Espace Aubade

**PRÉFIXE CODE - MEUBLE SOUS VASQUE**

Référence	Code	Taille/Format	Coloris	Prix public HT
200282	C003P4	70	BLANC	299,65€
200789	C003P2	70	NATURAL CAFÉ	296,86€
200624	C003P6	70	ROUGE	299,65€
200526	C003P5	70	GRIS PERLE	299,65€
200319	C0030K	80	BLANC	343,33€
200800	C0030L	80	NATURAL CAFÉ	340,15€
200627	C0031A	80	ROUGE	343,33€
200320	C74627	120	BLANC	476,60€
200801	C7462D	120	NATURAL CAFÉ	472,17€
200628	C7462F	120	ROUGE	476,60€
200544	C7462Y	120	GRIS PERLE	476,60€

Meuble à suspendre (livré monté). Disponible en 70, 80, 105 et 120 cm de large. Plan de toilette polybéton blanc brillant, simple ou double vasque avec remontée arrière.  
 Corps de meuble en panneau de particules mélaminé, décors tout bois en natural café ou crème, ou corps blanc brillant avec façades en panneau de particules mélaminé blanc, rouge ou gris perle brillant.  
 Meuble sous vasque faible profondeur avec 2 portes en 70 cm ou 3 portes en 105 cm.

**PRÉFIXE - PLAN POLYBETON**

Référence	Code	Taille/Format	Vasque	Prix public HT
813873	C003P0	70	SIMPLE	106,66€
814015	C0031D	80	SIMPLE	121,10€
814017	C7462J	120	DOUBLE	161,86€

**PRÉFIXE - PLAN CÉRAMIQUE**

Référence	Code	Taille/Format	Vasque	Prix public HT
814003	C005V9	70	SIMPLE	153,24€
814004	C7462K	80	SIMPLE	167,67€
813878	C7462L	120	DOUBLE	371,46

**PRÉFIXE - MIROIR DECO**

Référence	Code	Taille/Format	Vasque	Prix public HT
200058	C003OY	70		91,76€
200062	C7462M	80		104,80€
200296	C0059D	120		144,39€



PRÉFIXE - ACCESSOIRES				
Référence	Code	Taille/Format		Prix public HT
814155	C74620		ECLAIRAGE HALOGENE IP 44	46,58€
813886	C0030Z	25 CM	JEU DE 2 PIEDS CHROMES BRILLANTS	161,00€



FEDO - ENSEMBLE* BLANC				
Référence	Code	Taille/Format		Prix public HT
FEX60	C8194I	60		318,18€
FEX70	C8194J	70		329,54€
FEX90	C003CF	90		392,04€
FEX120	C00EF	120		498,85€

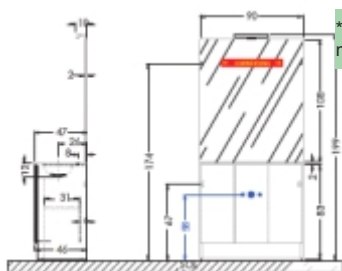

\* Ensemble meuble bas posé au sol avec portes, plan vasque moulé, miroir et applique halogène.

PROMOULE DECO - ENSEMBLE				
Référence	Code	Taille/Format	Coloris	Prix public HT
PML60050W	C00RL4	60	FAÇADE BLANC BRILLANT CORPS BLANC SATINE	412,49€
PML70050W	C00RPR	70		423,85€
PML90050W	C00RUD	90		528,40€
PML120050W	C00RGH	120		635,21€



\* Ensemble meuble bas suspendu avec portes, plan vasque moulé, miroir et applique halogène.  
Façades blanc brillant, corps blanc satiné.

PROMOULE DECO - ENSEMBLE				
Référence	Code	Taille/Format	Coloris	Prix public HT
PML60737GF	C00RMS	60	FAÇADES GRAPHITE BRILLANT CORPS GRAPHITE SATINE	412,49€
PML70737GF	C00RRD	70		423,85€
PML90737GF	C00RW1	90		528,40€
PML120737GF	C00RI5	120		635,21€



\* Ensemble meuble bas suspendu avec portes, plan vasque moulé, miroir et applique halogène.  
Façades graphite brillant, corps graphite satiné.



PROMOULE DECO - ENSEMBLE MEUBLE				
Référence	Code	Taille/Format	Coloris	Prix public HT
PML60738AE	C00RMW	60	FAÇADES HAVANE BRILLANT CORPS HAVANE SATINE	412,49€
PML70738AE	C00RRH	70		423,85€
PML90738AE	C00RW5	90		528,40€
PML120738AE	C00R19	120		635,21€

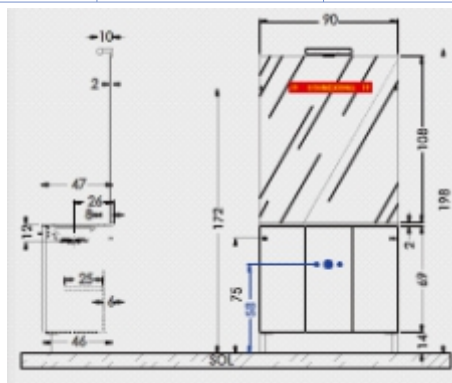

PROCERAM DECO - ENSEMBLE MEUBLE				
Référence	Code	Taille/Format	Coloris	Prix public HT
PCR63050W	C00R1Z	60	FAÇADES BLANC BRILLANT CORPS BLANC SATINE	483,99€
PCR93050W	C00R6K	90		618,99€
PCR123050W	C001VJ	120		826,98€

\* Ensemble meuble bas suspendu avec portes, plan céramique, miroir et applique halogène.  
Façades blanc brillant, corps blanc satiné.

PROCERAM DECO - ENSEMBLE MEUBLE				
Référence	Code	Taille/Format	Coloris	Prix public HT
PCR63737GF	C00KZT	60	FAÇADES GRAPHITE BRILLANT CORPS GRAPHITE SATINE	483,99€
PCR93737GF	C00KF9	90		618,99€
PCR123737GF	C00QYZ	120		826,98€

\* Ensemble meuble bas suspendu avec portes, plan céramique, miroir et applique halogène.  
Façades graphite brillant, corps graphite satiné.



PROCERAM DECO - ENSEMBLE MEUBLE				
Référence	Code	Taille/Format	Coloris	Prix public HT
PCR63738AE	C00R3P	60	FAÇADES HAVANE BRILLANT CORPS HAVANE SATINE	483,99€
PCR93738AE	C00R8B	90		618,99€
PCR123738AE	C00QZ3	120		826,98€

\* Ensemble meuble bas suspendu avec portes, plan céramique, miroir et applique halogène.  
Façades havane brillant, corps havane satiné.

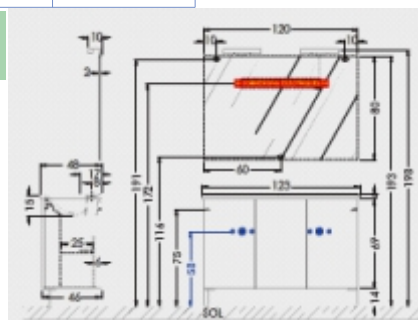

D-MOTION - CORPS BAS OUVRANT				
Référence	Code	Taille/Format	Coloris	Prix public HT
BBKV60NC	C00LRD	H48 L60	NATURA CLAIR	223,00€
BBKV60W	C00LRG	H48 L60	BLANC SATINE	223,00€
BBKV80NC	C00LRL	H48 L80	NATURA CLAIR	231,00€
BBKV80W	C00LS0	H48 L80	BLANC SATINE	231,00€



D-MOTION - CORPS BAS COULISSANT				
Référence	Code	Taille/Format	Coloris	Prix public HT
BBKVCX60NC	C00LQZ	H48 L60	NATURA CLAIR	267,00€
BBKVCX60W	C00LR2	H48 L60	BLANC SATINE	267,00€
BBKVCX80NC	C00LR6	H48 L80	NATURA CLAIR	285,00€
BBKVCX80W	C00LR9	H48 L80	BLANC SATINE	285,00€
BBKVCX120NC	C00LQS	H48 L120	NATURA CLAIR	336,00€
BBKVCX120W	C00LQV	H48 L120	BLANC SATINE	336,00€
BAKC40NC	C00LQJ	H34 L40	NATURA CLAIR	185,00€
BAKC40W	C00LQM	H34 L40	BLANC SATINE	185,00€
BAKCX60NC	C00LQ0	H34 L60	NATURA CLAIR	212,00€
BAKCX60W	C00LQ3	H34 L60	BLANC SATINE	212,00€
BAKCX80NC	C00LQB	H34 L80	NATURA CLAIR	227,00€
BAKCX80W	C00LQE	H34 L80	BLANC SATINE	227,00€



D-MOTION - PORTE OUVRANTE				
Référence	Code	Taille/Format	Coloris	Prix public HT
FPO4130707	C00OJF	H41 L30	NATURA CLAIR	54,00€
FPO4130122	C00OJ8	H41 L30	BLANC SATINE	54,00€
FPO4140707	C00S5H	H41 L40	NATURA CLAIR	63,00€
FPO4140122	C00S5A	H41 L40	BLANC SATINE	63,00€



D-MOTION - FAÇADE COULISSANTE				
Référence	Code	Taille/Format	Coloris	Prix public HT
FPC4160707	C00OIX	H41 L60	NATURA CLAIR	63,00€
FPC4160122	C00OIT	H41 L60	BLANC SATINE	63,00€
FPC4180707	C00OJ4	H41 L80	NATURA CLAIR	72,00€
FPC4180122	C00OJ0	H41 L80	BLANC SATINE	72,00€
FPC41120707	C00OIQ	H41 L120	NATURA CLAIR	82,00€
FPC41120122	C00OIM	H41 L120	BLANC SATINE	82,00€
FPC2740707	C00OH6	H27 L40	NATURA CLAIR	40,00€
FPC2670707	C00OHH	H27 L40	BLANC SATINE	40,00€



**D-MOTION - FAÇADE COULISSANTE**

Référence	Code	Taille/Format	Coloris	Prix public HT
FPC2760707	C00OHH	H27 L60	NATURA CLAIR	43,00€
FPC2760122	C00OHA	H27 L60	BLANC SATINE	43,00€
FPC2780707	C00P7P	H27 L80	NATURA CLAIR	46,00€
FPC2780122	C00P7S	H27 L80	BLANC SATINE	46,00€

**D-MOTION - TUBULURE EXTENSIBLE DÉPORT SIPHON**

Référence	Code	Taille/Format	Coloris	Prix public HT
SATO01	C00P7M			10,00€

**D-MOTION - PLAN VASQUE MOULE**

Référence	Code	Taille/Format	Coloris	Prix public HT
FRDM6C01	C00OLG	P46 L60		144,00€
FRDM8C01	C00OLH	P46 L80		154,00€
FRDM12D01	C00OLE	P46 L120	DOUBLE VASQUE	234,00€

**D-MOTION - PLAN TOILETTE STRATIFIE**

Référence	Code	Taille/Format	Coloris	Prix public HT
P2SPC14046707	C00SA6	P46 L40	NATURA CLAIR	31,00€
P2SPC14046122	C00SA2	P46 L40	BLANC SATINE	31,00€
P2SPC16046707	C00SAD	P46 L60	NATURA CLAIR	47,00€
P2SPC16046122	C00SA9	P46 L60	BLANC SATINE	47,00€
P2SPC18046707	C00SAK	P46 L80	NATURA CLAIR	62,00€
P2SPC18046122	C00SAG	P46 L80	BLANC SATINE	62,00€
P2SPC112046707	C00S9S	P46 L120	NATURA CLAIR	93,00€
P2SPC112046122	C00S9O	P46 L120	BLANC SATINE	93,00€

**D-MOTION - PAIRE SUPPORTS ETAGERES CHROMES BRILLANTS**

Référence	Code	Taille/Format	Coloris	Prix public HT
SECC618	C00SAW			30,00€

D-MOTION - MIROIR DECO				
Référence	Code	Taille/Format	Coloris	Prix public HT
MIRDC155560707	C00QQX	H55 L60	NATURA CLAIR	94,00€
MIRDC155560122	C00QQT	H55 L60	BLANC SATINE	94,00€
MIRDC155580707	C00QR4	H55 L80	NATURA CLAIR	125,00€
MIRDC155580122	C00QR0	H55 L80	BLANC SATINE	125,00€
MIRDC1555120707	C00QQJ	H55 L120	NATURA CLAIR	188,00€
MIRDC1555120122	C00QQF	H55 L120	BLANC SATINE	188,00€



D-MOTION - ARMOIRE TOILETTE				
Référence	Code	Taille/Format	Coloris	Prix public HT
AT5M60NC	C00IOB	H55 L60	NATURA CLAIR	900,00€
AT5M60W	C00IOF	H55 L60	BLANC SATINE	900,00€
AT5M80NC	C00IOJ	H55 L80	NATURA CLAIR	900,00€
AT5M80W	C00IOM	H55 L80	BLANC SATINE	900,00€



D-MOTION - NICHE DECO				
Référence	Code	Taille/Format	Coloris	Prix public HT
N2C40707	C00QUU	H27 L40	NATURA CLAIR	105,00€
N2C40122	C00QUQ	H27 L40	BLANC SATINE	105,00€
N2C80707	C00QV1	H27 L80	NATURA CLAIR	113,00€
N2C80122	C00QUX	H27 L80	BLANC SATINE	113,00€
N4C40707	C00QVB	H41 L40	NATURA CLAIR	120,00€
N4C40122	C00QV4	H41 L40	BLANC SATINE	113,00€
N4C80707	C00QVF	H41 L80	NATURA CLAIR	120,00€
N4C80122	C00QVB	H41 L80	BLANC SATINE	120,00€



D-MOTION - TABLETTE MURALE				
Référence	Code	Taille/Format	Coloris	Prix public HT
PDC16013707	C00RIP	P13 L60	NATURA CLAIR	13,00€
PDC16013122	C00RG9	P13 L60	BLANC SATINE	13,00€
PDC18013707	C00RIX	P13 L80	NATURA CLAIR	18,00€
PDC18013122	C00RIT	P13 L120	BLANC SATINE	18,00€
PDC112013707	C00RFO	P13 L120	NATURA CLAIR	26,00€
PDC112012122	C00RFK	P13 L120	BLANC SATINE	26,00€





LIBERTY - MEUBLE SOUS EVIER 2 PORTES						
Référence	Code	Taille/Format	L	H	P	Prix public HT
035AB208	C24334	80	800	820	586	102,77€
035AB209	C14664	90	900	820	586	102,77€
035AB210	C04921	100	1000	820	586	100,80€
035AB212 	C04922	120	1200	820	586	75,25€



LIBERTY - MEUBLE SOUS EVIER 3 PORTES						
Référence	Code	Taille/Format	L	H	P	Prix public HT
035AB312 	C04923	120	1200	820	586	82,78€
035AB314	C24312	140	1400	820	586	149,24€



LIBERTY - MEUBLE SOUS EVIER LAVE VAISSELLE (L.60)						
Référence	Code	Taille/Format	L	H	P	Prix public HT
241680	C04941	120	1200	820	586	122,71€



ENSEMBLE CUISINETTE*						
Référence	Code	Taille/Format	L	H	P	Prix public HT
KECR104.19	C1078D	100	1000			651,00€
KECR124.19	C1078C	120	1200			651,00€

\* Ensemble comprenant : 1 meuble bas + recouvrement inox L.60, 1 plaque électrique + 1 réfrigérateur 4\* Classe A 114 x 55.

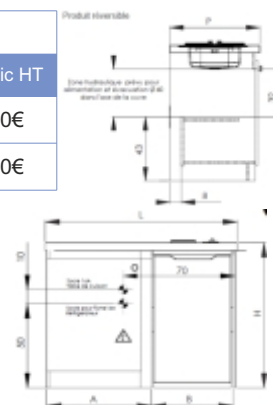

POP - MEUBLE LAVE-MAINS BLANC BRILLANT				
Référence	Code	Taille/Format		Prix public HT
817031873	C00802	40	GAUCHE	283,44€
817043873	C00803	40	DROITE	283,44€
811005873	C00804		MIROIR AVEC TABLETTE	72,74€



  
**DELPHA**  
Le meilleur de la salle de bains







RONDO DV - RÉSERVOIR ATTENDANT BLANC			
Référence	Code	Taille/Format	Prix public HT
31501010	C0543R		69,45€



PRIMO 08 - RÉSERVOIR HAUT BLANC			
Référence	Code	Taille/Format	Prix public HT
31080610	C0543U		46,16€



CLASSIC 42/06 - ENSEMBLE MÉCANISME TIRETTE ET ROBINET			
Référence	Code	Taille/Format	Prix public HT
38060007	C05417		16,61€



OPTIMA 49/95L - ENSEMBLE MÉCANISME POUSSOIR ET ROBINET			
Référence	Code	Taille/Format	Prix public HT
37950110	C2576A	ROBINET SILENCIEUX	32,53€

Compatible avec:

- trou de couvercle (A) ø de 18 à 50 mm
- trou d'évacuation (D) ø de 58 à 72 mm

Hauteur réglable (B):

- de 285 à 450 mm

Hauteur de surverse (C) ajustable:

- de 155 à 245 mm

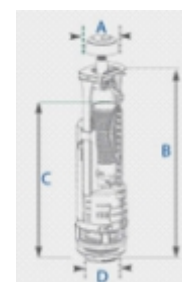

42B - MÉCANISME TIRETTE SEULE DOUBLE VOLUME			
Référence	Code	Taille/Format	Prix public HT
32420007	C05418		11,60€



22A - MÉCANISME POUSSOIR SEUL MONO-VOLUME			
Référence	Code	Taille/Format	Prix public HT
32225010	C05419		19,61€

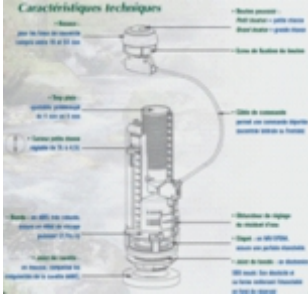

<b>OPTIMA 50 - MÉCANISME POUSSOIR SEUL</b>				
Référence	Code	Taille/Format		Prix public HT
32500010	C2576F			36,92€

<b>OPTIMA 49 - MÉCANISME POUSSOIR SEUL</b>				
Référence	Code	Taille/Format		Prix public HT
32490010	C0541C			33,40€

<b>ASPIRAMBO ASP 43 - PORCHER - MÉCANISME SEUL</b>				
Référence	Code	Taille/Format		Prix public HT
32425310	C10921			18,68€

<b>15 EL - ROBINET FLOTTEUR</b>				
Référence	Code	Taille/Format		Prix public HT
30100007	C05421			9,53€

<b>99B - ROBINET FLOTTEUR SILENCIEUX</b>				
Référence	Code	Taille/Format		Prix public HT
30990010	C67081			18,17€

<b>95L - ROBINET FLOTTEUR SILENCIEUX</b>				
Référence	Code	Taille/Format		Prix public HT
30950010	C05423			14,83€

<b>QUIETO 77L - ROBINET FLOTTEUR SUPER SILENCE</b>				
Référence	Code	Taille/Format		Prix public HT
30778010	C7038G			24,79€





MONACO - ABATTANT DOUBLE BLANC			
Référence	Code	Taille/Format	Prix public HT
48710117	C05402		13,20€



MONTE CARLO - ABATTANT DOUBLE BLANC			
Référence	Code	Taille/Format	Prix public HT
45525118	C25769		18,04€



BEAULIEU - ABATTANT DOUBLE BLANC			
Référence	Code	Taille/Format	Prix public HT
49305116	C05405		41,65€



OPIO - ABATTANT DOUBLE BLANC FREIN DE CHUTE			
Référence	Code	Taille/Format	Prix public HT
47105510	C0541G		49,68€



GENERATION - ABATTANT BLANC			
Référence	Code	Taille/Format	Prix public HT
95822110	C0541K	SIEGE ENFANT INCORPORE	49,32€



HORIZON NEIGE - ABATTANT DOUBLE BLANC			
Référence	Code	Taille/Format	Prix public HT
95826010	C05446		34,59€

Peut se raccorder à :



W12P - BROYEUR SEUL				
Référence	Code	Taille/Format	Coloris	Prix public HT
362702	C70389			562,80€

**Avantages**

- Intervention possible en milieu propre
- S'adapte facilement à toutes les cuvettes
- Permet de rapprocher la cuvette du mur



Peut se raccorder à :



W30P - CUVETTE A BROYEUR INTÉGRÉ COMPACT				
Référence	Code	Taille/Format	Coloris	Prix public HT
362820	C05564			789,60€

**Avantages**

- Puissant – Silencieux – Esthétique
- Écologique – Facile d'utilisation



Peut se raccorder à :



VD 120 - POMPE DE RELEVAGE				
Référence	Code	Taille/Format	Coloris	Prix public HT
WVD120	C7038C			625,80€

**Avantages**

- Raccordement cuisine, buanderie
- Raccordement salle de bain complète



Peut se raccorder à :



VD 100 - POMPE DE RELEVAGE EVACUATION BASSE				
Référence	Code	Taille/Format	Coloris	Prix public HT
WVD100	C7038A			531,30€

**Avantages**

- Faible encombrement, silencieuse
- Raccordement lavabo possible



**SANIBROYEUR - BROYEUR SEUL**

Référence	Code	Taille/Format	Coloris	Prix public HT
362900	C65900		SANIBROYEUR PRO	596,48€
SP1800	C6590C		SANIBROYEUR CORAIL	352,30€

Connexions possibles

- ✓ WC
- ✓ Lave-mains / Lavabo
- ✓ Douche
- ✓ Bidet

Refoulements vertical et horizontal : 5 m ➔ 100 m



**SANICOMPACT - CUVETTE BROYEUR COMPACT**

Référence	Code	Taille/Format	Coloris	Prix public HT
362930	C65905		SANICOMPACT 43	794,43€
SP1804	C6590D		SANICOMPACT CORAIL	641,29€

Connexions possibles

- ✓ Lave-mains / Lavabo
- ✓ Bidet

Refoulements vertical et horizontal : 3 m ➔ 30 m





VIDAGE BAIGNOIRE A CHAINETTE			
Référence	Code	Taille/Format	Prix public HT
551200000	C44962		9,55€



VIDAGE BAIGNOIRE AUTOMATIQUE STANDARD			
Référence	Code	Taille/Format	Prix public HT
582000000	C47970		25,05€



VIDAGE EVIER PVC BIBAC			
Référence	Code	Taille/Format	Prix public HT
780200000	C47650		6,62€



VIDAGE EVIER 1 CUVE GAIN DE PLACE			
Référence	Code	Taille/Format	Prix public HT
75110000100	C30223		8,89€



VIDAGE EVIER 2 CUVES GAIN DE PLACE			
Référence	Code	Taille/Format	Prix public HT
76210000100	C66565		13,50€



VIDAGE EVIER GRES 2 CUVES AVEC TROP PLEIN			
Référence	Code	Taille/Format	Prix public HT
785500000	C2576E		23,25€

<b>BONDE DE DOUCHE D90 SH</b>			
Référence	Code	Taille/Format	Prix public HT
571000000	C45695		17,25€



<b>BONDE DE DOUCHE D90 CHROMÉE MULTI-DIRECTION</b>			
Référence	Code	Taille/Format	Prix public HT
577600000	C45923		20,59€



<b>BONDE DE DOUCHE SH CAPOT CHROMÉ</b>			
Référence	Code	Taille/Format	Prix public HT
571500000	C80308		19,34€



<b>BONDE LAVABO SEULE</b>			
Référence	Code	Taille/Format	Prix public HT
100300000	C71638		16,86€



<b>BONDE LAVABO PVC A BOUCHON</b>			
Référence	Code	Taille/Format	Prix public HT
604200000	C47648		3,75€



<b>BONDE LAVABO PVC A GRILLE</b>			
Référence	Code	Taille/Format	Prix public HT
605100000	C45185		3,79€

Bonde plastique à écoulement libre  
 - grille plate inox ø63  
 - sortie fileté 1"1/4  
 - serrage mini 0 mm - maxi 55 mm  
 - débit 40 l/mn (sous 120 mm d'eau)



<b>BONDE LAVABO LAITON A GRILLE</b>			
Référence	Code	Taille/Format	Prix public HT
120100000	C45431		5,88€

Bonde laiton à écoulement libre  
 - grille plate inox ø63  
 - sortie fileté 1"1/4  
 - serrage mini 0 mm - maxi 55 mm  
 - débit 46 l/mn (sous 120 mm d'eau)



<b>BONDE LAVABO DIGICLIC UNIVERSELLE ABS</b>			
Référence	Code	Taille/Format	Prix public HT
122900000	C00E01		25,92€



**BONDE LAVABO LAITON CLIC CLAC**

Référence	Code	Taille/Format	Coloris	Prix public HT
122000000	C46672			27,49€

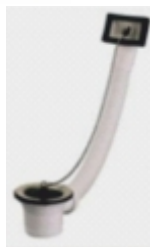
**BONDE EVIER INOX AVEC TROP PLEIN**

Référence	Code	Taille/Format	Coloris	Prix public HT
715100000	C46675			5,61€

**BONDE EVIER GRES AVEC GRILLE**

Référence	Code	Taille/Format	Coloris	Prix public HT
700100000	C47652			5,65€

Bonde pour évier ou timbre - grille marguerite inox ø85mm sans trop plein  
 - débit 65 l/mn (sous 120 mm d'eau)

**BONDE EVIER GRES A BOUCHON**

Référence	Code	Taille/Format	Coloris	Prix public HT
701100000	C47319			5,27€

Bonde à bouchon sans trop plein / cuvette inox ø 85 mm  
 - bouchon avec enjoliveur, chaînette 250 mm  
 et borne d'attache  
 - débit 70 l/mn (sous 120 mm d'eau)

**BONDE LAITON EVIER GRES A BOUCHON**

Référence	Code	Taille/Format	Coloris	Prix public HT
352200000	C46676			8,57€

**BONDE EVIER A PANIER SANS TROP PLEIN**

Référence	Code	Taille/Format	Coloris	Prix public HT
390000000	C45922			16,48€



<b>SIPHON LAVABO PVC</b>			
Référence	Code	Taille/Format	Prix public HT
610300001	C47647		2,37€



<b>SIPHON LAVABO LAITON CHROME</b>			
Référence	Code	Taille/Format	Prix public HT
130300000	C47974		18,83€



<b>SIPHON BIDET PVC</b>			
Référence	Code	Taille/Format	Prix public HT
615300100	C47000		2,53€



<b>SIPHON EVIER PVC REGLABLE</b>			
Référence	Code	Taille/Format	Prix public HT
750300100	C47653		2,39€



<b>SIPHON SOL BLANC S</b>			
Référence	Code	Taille/Format	Prix public HT
462100000	C45702	100x100	8,55€

Bonde de sol carrée 100 x 100 mm  
 - grille inox à cloche ø85 mm  
 - sortie verticale ø40 à coller sur tube ou sur coude  
 - débit : 24 l/mn (sous 30 mm d'eau)



<b>SIPHON SOL GRIS S</b>			
Référence	Code	Taille/Format	Prix public HT
462300000	C44967	140x140	13,20€

Bonde de sol carrée 140 x 140 mm  
 - grille inox à cloche ø107 mm  
 - sortie verticale ø40 à coller sur tube ou sur coude  
 - débit : 26 l/mn (sous 30 mm d'eau)



<b>SIPHON SOL INOX</b>			
Référence	Code	Taille/Format	Prix public HT
460200000	C51572	100x100	33,22€

Bonde de sol carrée 100 x 100 mm  
 - grille inox à cloche ø90 mm avec ergots  
 - sortie tube laiton verticale ø40 à souder  
 - débit : 20 l/mn (sous 30 mm d'eau)





PORTE SERVIETTE 1 BARRE FIXE				
Référence	Code	Taille/Format		Prix public HT
030151	C72194			30,87€



PORTE SERVIETTE 2 BARRES MOBILES				
Référence	Code	Taille/Format		Prix public HT
030112	C45631			62,89€

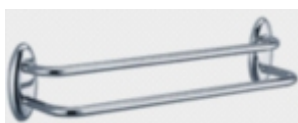

PORTE SERVIETTE 2 BARRES FIXES				
Référence	Code	Taille/Format		Prix public HT
030252	C0005J			49,27€



PORTE PEIGNOIRE				
Référence	Code	Taille/Format		Prix public HT
003731	C46629		1 TETE	12,89€
003742	C72195		2 TETES	42,63€



PORTE SAVON MURAL AMOVIBLE				
Référence	Code	Taille/Format		Prix public HT
005141	C47921			34,59€



PORTE PAPIER WC ROULEAU				
Référence	Code	Taille/Format		Prix public HT
003511	C46934			36,11€



DISTRIBUTEUR DE SAVON LIQUIDE				
Référence	Code	Taille/Format		Prix public HT
004113	C000CB			53,15€

<b>BARRE DE RELÈVEMENT CHROMÉE</b>				
Référence	Code	Taille/Format		Prix public HT
002943	C45376	L300 DN25		32,04€



<b>BARRE DE RELÈVEMENT LAITON CHROMÉ</b>				
Référence	Code	Taille/Format		Prix public HT
002905	C0018N	L500		57,07€



<b>BARRE DE RELÈVEMENT ANGLE 135° LAITON CHROMÉ</b>				
Référence	Code	Taille/Format		Prix public HT
043535	C0019M	L400x400	Dn25	91,18€



<b>BARRE DE RELÈVEMENT ANGLE 135° LAITON CHROMÉ</b>				
Référence	Code	Taille/Format		Prix public HT
043533	C00HEC	L400x400		80,89€

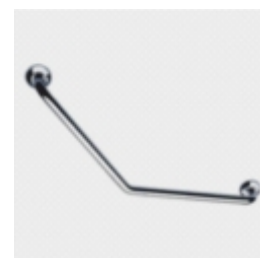

<b>BARRE DE RELÈVEMENT ANGLE 135° LAITON CHROMÉ</b>				
Référence	Code	Taille/Format		Prix public HT
043532	C0015L	L200x200	Dn25	55,79€



<b>BARRE DE RELÈVEMENT ALU EPOXY BLANC</b>				
Référence	Code	Taille/Format		Prix public HT
049130	C0019T	L300 D30		29,09€

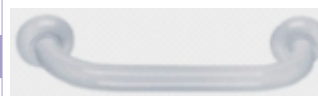

<b>BARRE DE RELÈVEMENT ALU EPOXY BLANC</b>				
Référence	Code	Taille/Format		Prix public HT
049160	C0019V	L600 D30		40,80€



<b>BARRE DE RELÈVEMENT ANGLE 135° BLANCHE</b>				
Référence	Code	Taille/Format		Prix public HT
049230	C002KE	L400x400	Dn30	50,38€



**BARRE APPUI RELEVABLE EPOXY BLANC**

Référence	Code	Taille/Format	Coloris	Prix public HT
048860	C0019S	L600		154,50€

**SIÈGE DE DOUCHE ESCAMOTABLE GRANDE TAILLE**

Référence	Code	Taille/Format	Coloris	Prix public HT
047632	C00HEE	580x360x500		189,21€

**SIÈGE DE DOUCHE ESCAMOTABLE**

Référence	Code	Taille/Format	Coloris	Prix public HT
047630	C0019X	380x355x500		135,93€

**PAIRE DE SUPPORTS DE TABLETTE**

Référence	Code	Taille/Format	Coloris	Prix public HT
006012	C47263			12,33€

**TABLETTE VERRE**

Référence	Code	Taille/Format	Coloris	Prix public HT
005586	C46935	600x120		17,60€

**MIROIR**

Référence	Code	Taille/Format	Coloris	Prix public HT
005574	C05001	600x400		35,25€

**LOT 4 AGRAFES MIROIR TAQUET CABOCHON**

Référence	Code	Taille/Format	Coloris	Prix public HT
007124	C0013S			6,41€

<b>PORTE RIDEAU DROIT</b>				
Référence	Code	Taille/Format		Prix public HT
004827	C0013W	80		21,42€
004832	C0013X	90		24,70€
004834	C0013Y	100		26,33€



<b>TUBE DROIT EXTENSIBLE</b>				
Référence	Code	Taille/Format		Prix public HT
004921	C45377	620 A 1020		60,32€



<b>RIDEAU DE DOUCHE BLANC</b>				
Référence	Code	Taille/Format		Prix public HT
804090	C0014A	90x180		14,39€
804120	C44660	120x180		17,46€
804180	C47598	180x180		23,59€



<b>EMBASE COULISSANTE AVEC VIS ET CHEVILLES</b>				
Référence	Code	Taille/Format		Prix public HT
004705	C0014B			12,35€



<b>COUDE ET 2 MANCHONS ASSEMBLAGE</b>				
Référence	Code	Taille/Format		Prix public HT
004719	C0014C			16,30€



<b>MANCHON DE RALLONGE</b>				
Référence	Code	Taille/Format		Prix public HT
004843	C0015K			6,18€



<b>TENDEUR PLAFOND</b>				
Référence	Code	Taille/Format		Prix public HT
004802	C47266			23,64€

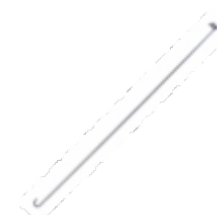





FLY - PORTE SERVIETTE 1 BRANCHE FIXE				
Référence	Code	Taille/Format		Prix public HT
Q3618BCR	C006FC	40		49,33€
Q3618CCR	C006G1	52		55,18€



FLY - PORTE PEIGNOIR				
Référence	Code	Taille/Format		Prix public HT
Q3620ACR	C006G4		SIMPLE	24,25€
Q3620BCR	C006G6		DOUBLE	29,26€



FLY - PORTE SAVON				
Référence	Code	Taille/Format		Prix public HT
Q36110CR21	C006GA		AVEC COUPELLE	36,97€
C36490CR	C006GD		FIL	57,69€



FLY - DIVERS				
Référence	Code	Taille/Format		Prix public HT
Q36100CR21	C006GB		PORTE VERRE AVEC VERRE	36,79€
Q36120CR21	C006GC		DISTRIBUTEUR DE SAVON LIQUIDE	57,69€



FLY - PORTE PAPIER WC A ROULEAU				
Référence	Code	Taille/Format		Prix public HT
Q36250CR	C006GJ			35,12€



FLY - PORTE SERVIETTE SOL				
Référence	Code	Taille/Format		Prix public HT
QV085DCR	C006GL			82,77€

FLY - PORTE BALAYETTE AVEC BALAYETTE				
Référence	Code	Taille/Format	Coloris	Prix public HT
Q36140CR21	C006GK			60,20€



FLY - PORTE ROULEAU PAPIER TOILETTE AVEC BALAYETTE				
Référence	Code	Taille/Format	Coloris	Prix public HT
QV086DCR	C006GY			82,77€



MIROIRS MULTIMÉDIA ECLAIRAGE INTÉGRÉ IP44				
Référence	Code	Taille/Format	Eclairage	Prix public HT
MIRMEDIA	C74633	70 x 50 x 6	INTEGRE IP44	485,00€

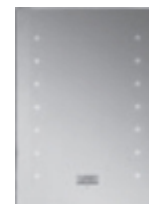

MIROIRS CHROMOTHERAPIE LED IP44 INTÉGRÉE				
Référence	Code	Taille/Format	Eclairage	Prix public HT
MIRCHROMO 01	C74634	85 x 85 x 3		429,00€
MIRCHROMO 02	C74635	60 x 100 x 3		394,00€



MIROIRS AVEC FLUO INTÉGRÉ IP44				
Référence	Code	Taille/Format	Eclairage	Prix public HT
MIRFLUO 01	C74636	80 x 60 x 3		206,00€
MIRFLUO 02	C74637	80 x 90 x 3		249,00€
MIRFLUO 03	C74638	80 x 120 x 3		278,00€
MIRFLUO 04	C74639	80 x 140 x 3		291,00€
MIRFLUO 05	C7463F	70 x 70 x 3		209,00€



MIROIRS DE STAR FLUO INTÉGRÉ IP44				
Référence	Code	Taille/Format	Eclairage	Prix public HT
HZ20	C7461U	70 x 60 x 2		285,00€
HZ21	C001B5	70 x 100 x 2		320,00€
HZ22	C001B6	70 x 130 x 2		425,00€





# Nos agences à votre service

DÉPARTEMENT	VILLE	ADRESSE	TÉLÉPHONE	TELECOPIE
09 - ARIÈGE	FOIX	ZA de Permilhac -09000	05.61.02.12.00	05.61.02.12.08
	SAINTE-LIZIER	ZI Lorp Sentaraille - 09190	05.34.14.32.03	05.34.14.32.04
11 - AUDE	CASTELNAUDARY	ZA En Toure III - 11400	04.68.23.69.53	04.68.23.69.62
12 - AVEYRON	 RODEZ	ZA Bel Air - 12000	05.65.42.64.51	05.65.42.82.01
	 MILLAU	Rue de la Saunerie - 12100	05.65.60.15.05	05.65.60.79.18
	 VILLEFRANCHE DE R.	Route de Montauban - 12200	05.65.45.46.72	05.65.45.17.81
	DECAZEVILLE	35 Ter av.Victor Hugo - 12300	05.65.63.62.19	05.65.43.14.13
15 - CANTAL	 AURILLAC	ZA de Baradel - 9 av.Garric - 15000	04.71.45.60.05	04.71.64.59.00
19 - CORREZE	 BRIVE LA GAILLARDE	13 av.Malraux ZA de Cana - 19100	05.55.18.72.55	05.55.18.72.64
31 - HTE GARONNE	TOULOUSE	27-29 Chemin de la Glacière - 31200	05.62.72.43.63	05.62.72.43.66
	 MURET	44 bd Joffrey - ZI Marclan 31600	05.34.46.04.30	05.34.46.04.35
	SAINTE-GAUDENS	La Bachade - LANDORTHE 31800	05.61.89.70.60	05.61.88.38.65
46 - LOT	 FIGEAC	ZA Lafarrayrie - Rte de Cahors - 46100	05.65.50.06.36	05.65.50.06.37
	 LE VIGAN	ZA des Millepoises - 46300	05.65.41.78.80	05.65.41.78.81
48 - LOZERE	 MENDE	Av.du 11 novembre - 48000	04.66.49.65.77	04.66.49.65.79
81 - TARN	ALBI	22 rue de la Poudrière - 81000	05.63.43.21.90	05.63.43.21.94
	 ALBI	Chemin du Verbial - 81000	05.63.49.66.66	05.63.38.21.81
	 CASTRES	136 Route de Toulouse - Mélou - 81100	05.63.72.85.85	05.63.72.85.72
	GRAULHET	18 Bis rue du Docteur Pontier - 81300	05.63.34.26.72	05.63.34.66.88
82 - TARN ET GARONNE	 MONTAUBAN	Avenue de l'Europe - Albasud - 82000	05.63.91.87.60	05.63.91.87.69

VOTRE REPRESENTANT

